

DESIGNER	JOHN ROBERT	MARKED PROJECT
DESIGNER	EDWIN LEE ZAMON	
DESIGNER	GENE RODDENBERRY	
APPROVALS		
PROTOTYPE UPGRADE TO PRODUCTION STANDARDS		
GALAXY	U.S.S. ENTERPRISE	
NCC-1701-D		
MC. TIG HEAVY CRUISER	OUTBOARD OVERHEAD PLAN VIEW	
GRID SCALE	4000.0	
MC. TIG GRID SCALE	41700.0	
		1 OF 13

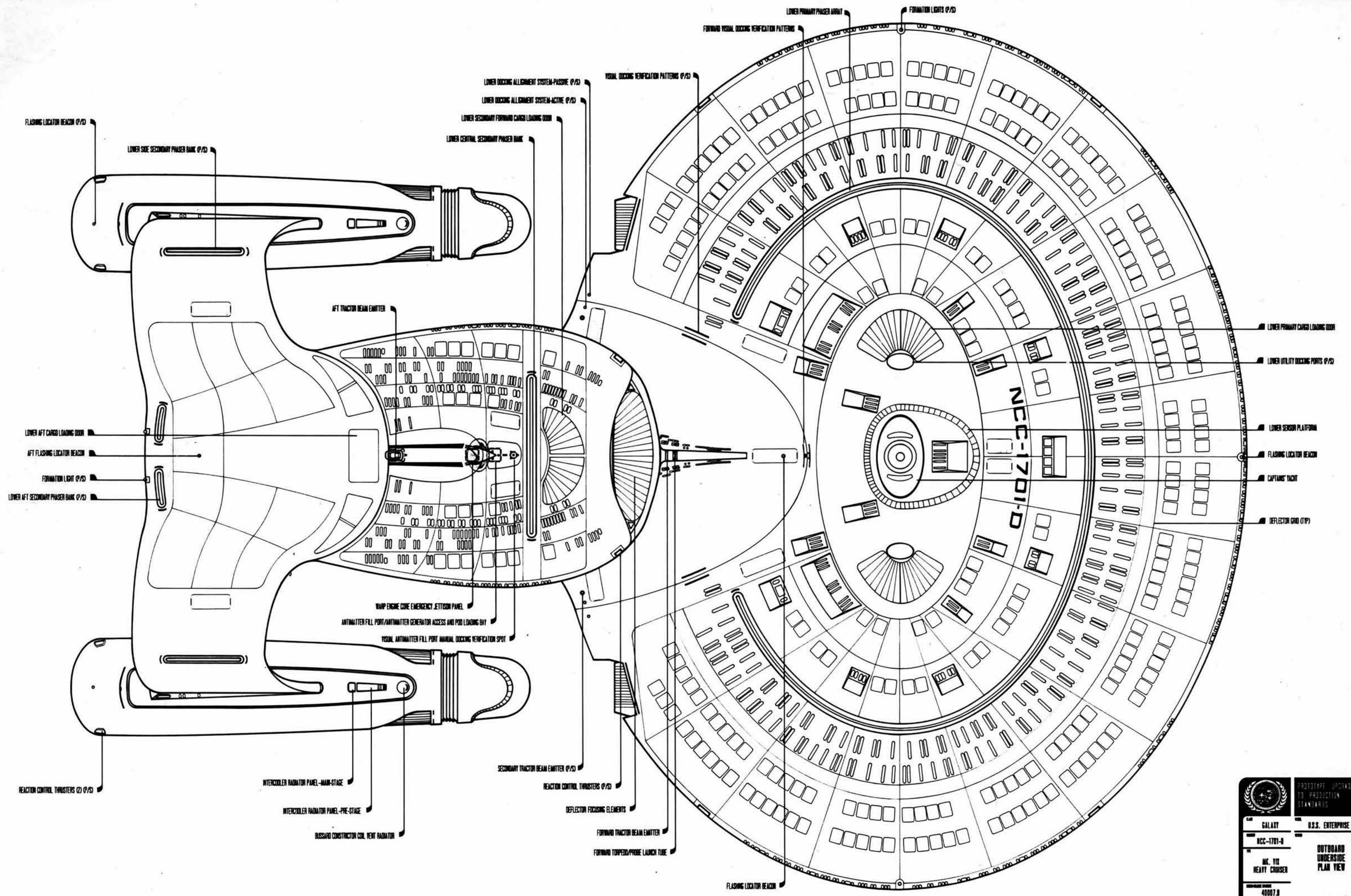

		PROTOTYPE UPDATE TO PRODUCTION STANDARDS
GALAXY	U.S.S. ENTERPRISE	
NCC-1701-D		
MC. VII HEAVY CRUISER	OUTBOARD UNDERSIDE PLAN VIEW	
4007.8		
41700.3	2 OF 10	

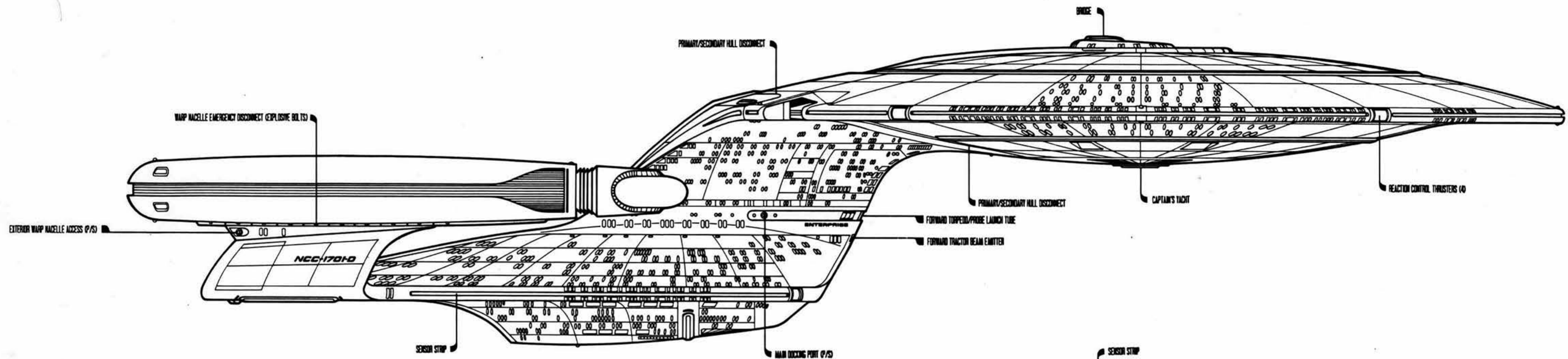

STARBOARD

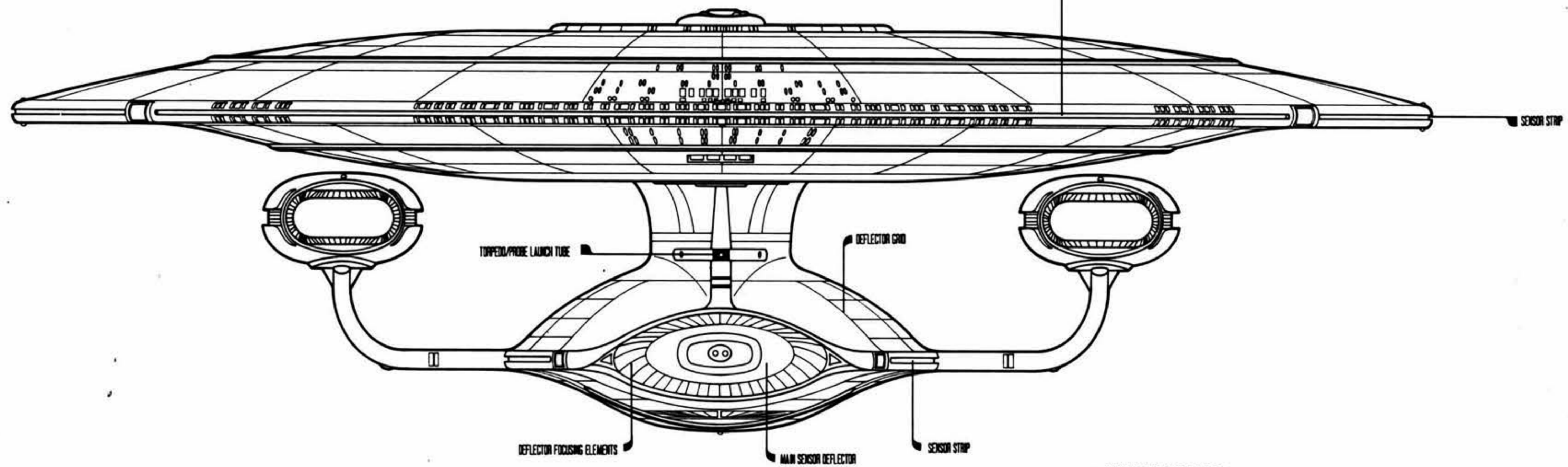

BOW

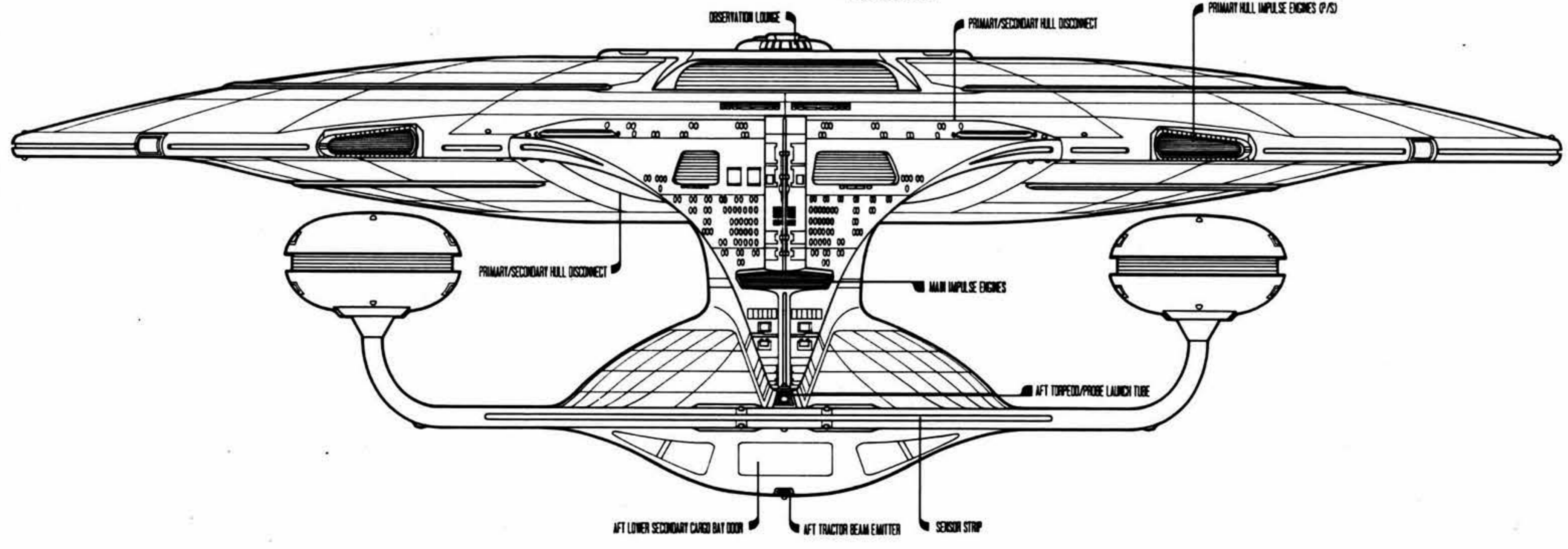

STERN

PARTICULARS	
PRIME CONTRACTOR:	UTOPIA PLANETIA, UTOPIA PLANETIA YARDS, MARS
OVERALL LENGTH:	842.5 meters (2,768 ft.)
OVERALL BEAM:	407.2 meters (1,338 ft.)
OVERALL DEPTH:	137.8 meters (452 ft.)
MASS:	APPROX. 5,000,000 METRIC TONS
AVAILABLE DECK SPACE:	APPROX. 11,500,000 sq.ft.
ACCESSIBLE VOLUME:	APPROX. 80,720,000 cu.ft.
STANDARD CREW COMPLEMENT:	1,012 (OFFICERS, ENLISTED, AND CIVILIAN PERSONNEL)
ADDITIONAL CREW CAPACITY:	3,400 PERSONNEL ADDITIONAL
MAXIMUM EMERGENCY CAPACITY:	10,000
MAXIMUM VELOCITY:	APPROX. WARP 9.7
ENDURANCE (UNREFUELED):	APPROX. 3 YEARS NORMAL CRUISING
PERSONNEL TRANSPORT CAPABILITIES:	
TRANSPORTERS	SHUTTLECRAFT
- 8 STANDARD PERSONNEL (8 PERSON)	- 10 STANDARD PERSONNEL (1 PERSON)
- 8 CARGO	- 20 STANDARD UTILITY (1 PERSON SHUTTLE MINUS SEATING)
- 8 EMERGENCY (40 PERSON) (OUT-BEAM ONLY)	- 8 LARGE PERSONNEL (22 PERSON)
	- 3 WARP SLEDS (FOR LARGE SHUTTLES)
	- 30 SHUTTLEPODS (2 PERSON)
	- 20 SPHINX WORKSLEDS (2 PERSON)

	PROTOTYPE UPGRADE TO PRODUCTION STANDARDS
GALATI	U.S.S. ENTERPRISE
NCC-1701-B	OUTBOARD ELEVATIONS
MC. VII HEAVY CRUISER	- STARBOARD
40007.8	- BOW
41700.3	- STERN
	3 OF 13

BATTLEHEAD SECONDARY HULL

- DECK 0 BATTLE BRIDGE, EMERGENCY SYSTEMS, MAIN PRIMARY HULL ACCESS
- DECK 1 EMERGENCY SYSTEMS, LIFE/ENVIRONMENTAL, DOCKING LATCHES
- DECK 2 PRINSEK BUNK SUPPORT, POWER BUS, EMERGENCY BATTERIES, DOCKING LATCHES
- DECK 3 LIFE/ENVIRONMENTAL SUPPORT EQUIPMENT, SCIENCE LABS, DOCKING LATCHES
- DECK 4 SCIENCE LABS, DOCKING LATCHES
- DECK 5 SHUTTLE BAYS, DOCKING LATCHES
- DECK 6 SHUTTLE BAY SUPPORT, TRANSPORTERS, SHIP DOCKING LATCHES
- DECK 7 SCIENCE LABS

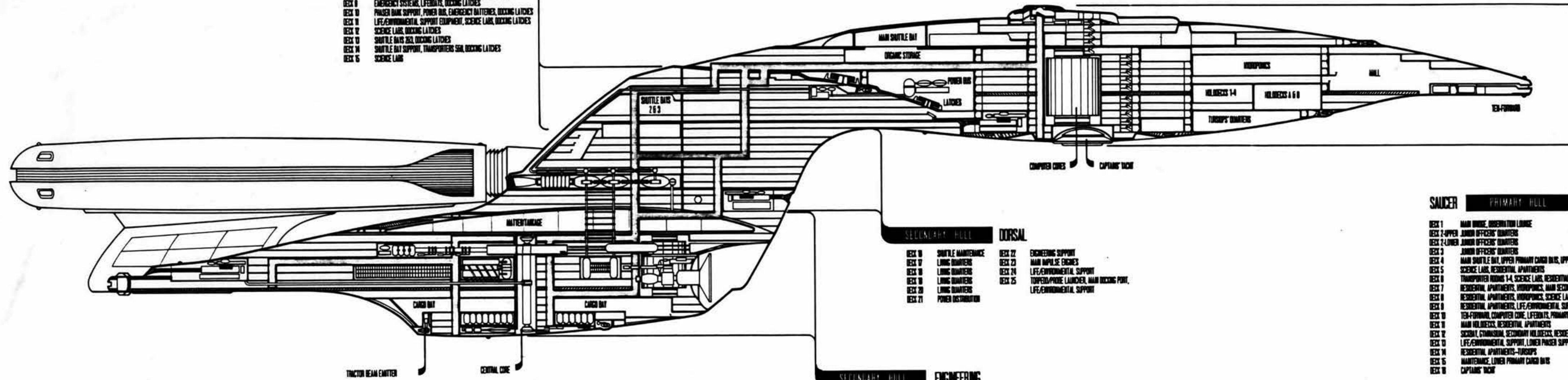

SECONDARY HULL DORSAL

- DECK 16 SHUTTLE MAINTENANCE
- DECK 17 LIVING QUARTERS
- DECK 18 LIVING QUARTERS
- DECK 19 LIVING QUARTERS
- DECK 20 LIVING QUARTERS
- DECK 21 POWER DISTRIBUTION
- DECK 22 ENGINEERING SUPPORT
- DECK 23 MAIN IMPULSE ENGINES
- DECK 24 LIFE/ENVIRONMENTAL SUPPORT
- DECK 25 TURBO/PINDE LAUNCHER, MAIN DOCKING POINT, LIFE/ENVIRONMENTAL SUPPORT

SECONDARY HULL ENGINEERING

- DECK 26 BETHENAN OXYGEN/FUEL STORAGE
- DECK 27 BETHENAN OXYGEN/FUEL STORAGE, CIRCULATION PUMPS, FILL PORTS
- DECK 28 BETHENAN OXYGEN/FUEL STORAGE, CIRCULATION PUMPS
- DECK 29 BETHENAN OXYGEN/FUEL STORAGE, DUMP POINTS, INJECTION REACTORS
- DECK 30 UPPER SENSOR PLATFORM, SCIENCE LABS
- DECK 31 SCIENCE LABS, SENSORS
- DECK 32 LIVING QUARTERS, SENSORS
- DECK 33 LIVING QUARTERS, SENSORS, LIFE/ENVIRONMENTAL SUPPORT
- DECK 34 LIVING QUARTERS, SENSORS, LIFE/ENVIRONMENTAL SUPPORT
- DECK 35 LIVING QUARTERS, AFT TURBO/PINDE LAUNCHER, ENGINEERING SUPPORT
- DECK 36 MAIN ENGINEERING, LIFE/ENVIRONMENTAL, COMPUTER CORE, SENSORS
- DECK 37 LIFE/ENVIRONMENTAL SUPPORT, ENGINEERING SUPPORT, SECONDARY WASTE MANAGEMENT
- DECK 38 SECONDARY CARD BAYS, SCIENCE LABS
- DECK 39 SECONDARY CARD BAYS, SCIENCE LABS
- DECK 40 ANTIMATTER FUEL STORAGE POND, LIFE/ENVIRONMENTAL SUPPORT
- DECK 41 ANTIMATTER FUEL STORAGE POND
- DECK 42 ANTIMATTER INJECTION REACTORS, ANTIMATTER FILL AND DUMP POINTS

SAUCER PRIMARY HULL

- DECK 1 MAIN BRIDGE, OBSERVATION LOUNGE
- DECK 2 UPPER JUNIOR OFFICERS' QUARTERS
- DECK 3 LOWER JUNIOR OFFICERS' QUARTERS
- DECK 4 JUNIOR OFFICERS' QUARTERS
- DECK 5 MAIN SHUTTLE BAY, UPPER PRIMARY CARD BAYS, UPPER PRINSEK SUPPORT
- DECK 6 SCIENCE LABS, RESIDENTIAL APARTMENTS
- DECK 7 TRANSPORTER ROOMS 1-4, SCIENCE LABS, RESIDENTIAL APARTMENTS
- DECK 8 RESIDENTIAL APARTMENTS, HODOPONKS, MAIN SECONDARY HULL ACCESS
- DECK 9 RESIDENTIAL APARTMENTS, HODOPONKS, SCIENCE LABS
- DECK 10 RESIDENTIAL APARTMENTS, LIFE/ENVIRONMENTAL SUPPORT
- DECK 11 TER-FORMAL, COMPUTER CORE, LIFE/ENVIRONMENTAL SUPPORT
- DECK 12 MAIN HULLS 5 & 6, RESIDENTIAL APARTMENTS
- DECK 13 SECONDARY HULLS, SECONDARY HULLS 5 & 6, RESIDENTIAL APARTMENTS
- DECK 14 LIFE/ENVIRONMENTAL SUPPORT, LOWER PRINSEK SUPPORT
- DECK 15 RESIDENTIAL APARTMENTS-TURBOPUMP
- DECK 16 MAINTENANCE, LOWER PRIMARY CARD BAYS
- DECK 17 CAPTAIN'S YACHT

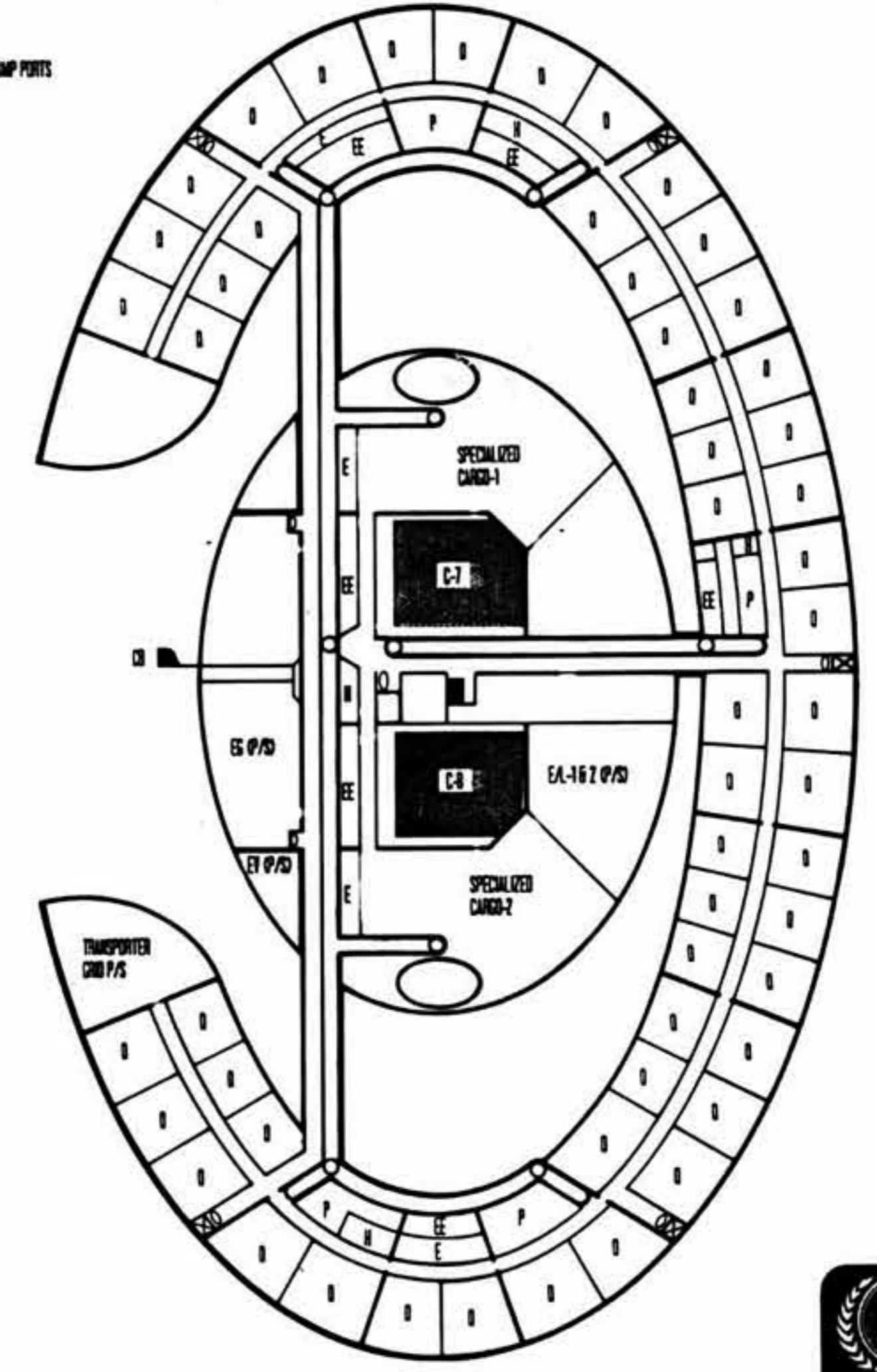
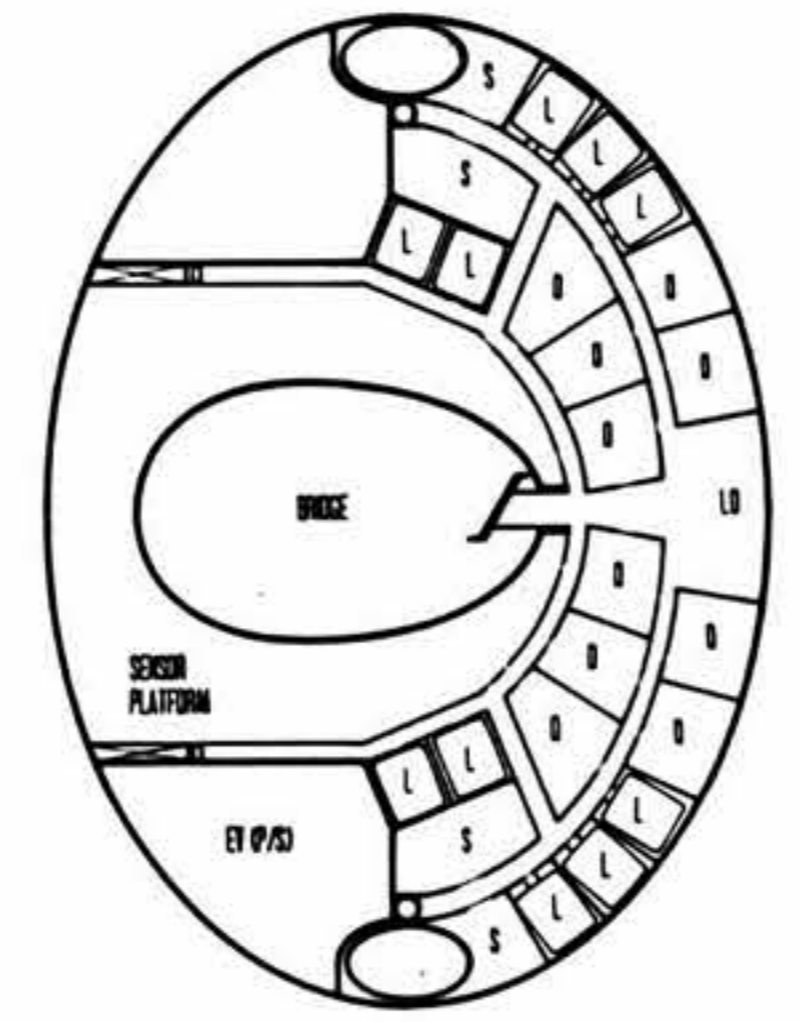
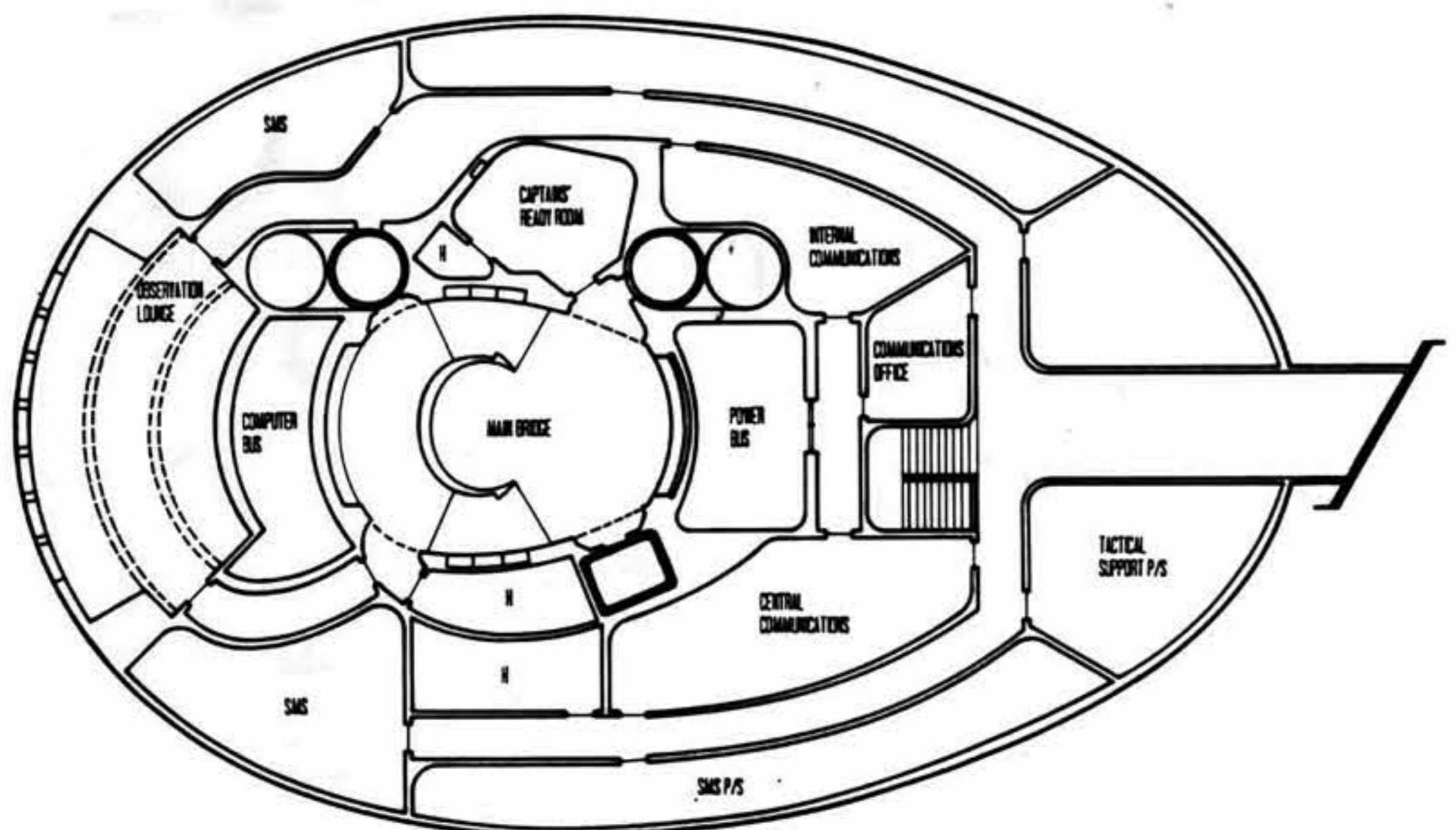

		PROTOTYPE, UPGRADE TO PRODUCTION STANDARDS	
CLASS	GALAXY	NAME	U.S.S. ENTERPRISE
MODEL	NCC-1701-D	SECTION	CENTERLINE VERTICAL SECTION - PRIMARY HULL
SCALE	1/4" = 10'	DETAILS	- BRIDGE DETAIL ENLARGED
DESIGNER	40007.J	DATE	DECK 20 - DECK 20
BY	41788.J	PAGE	4 OF 13

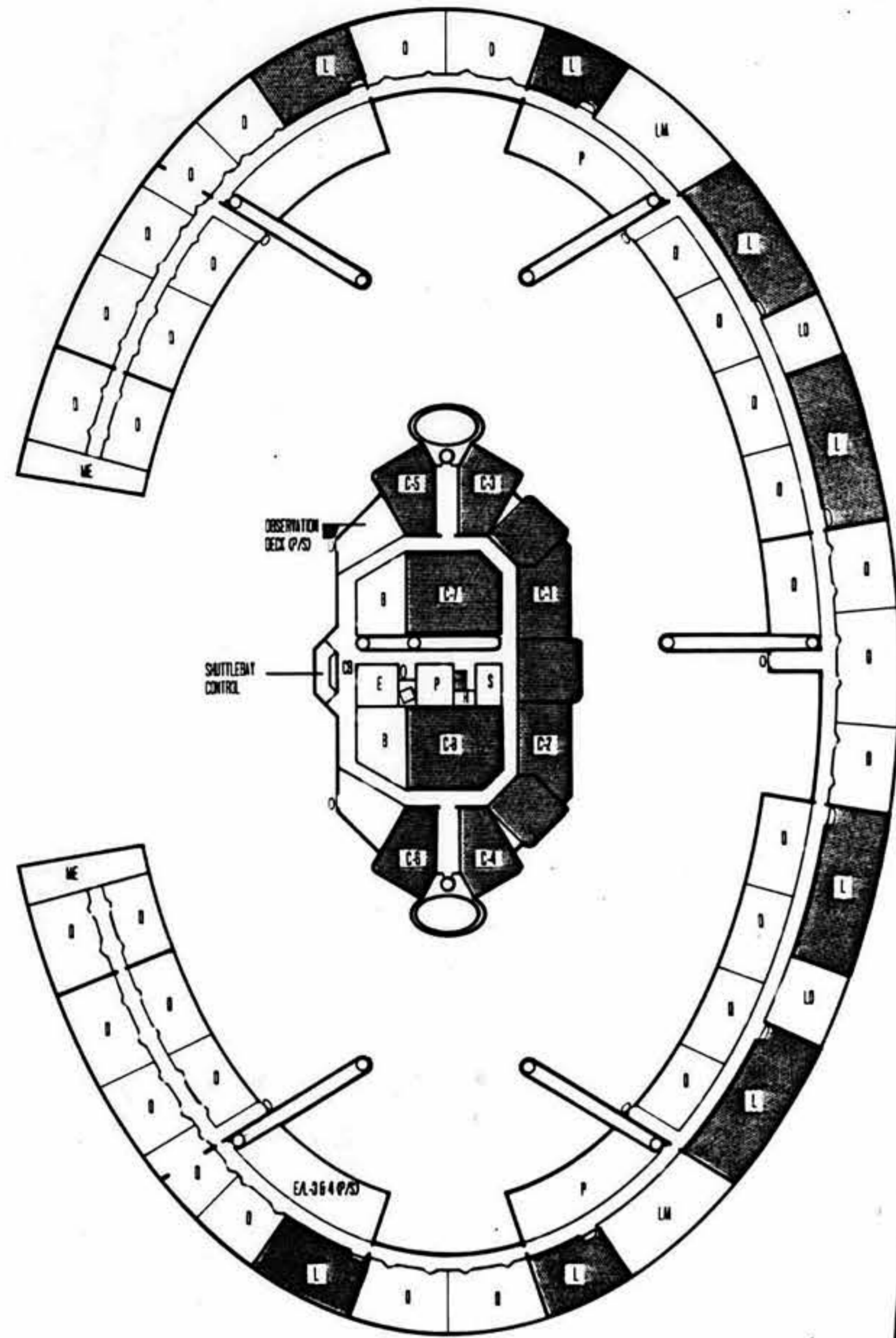

DECK 3
JUNIOR OFFICERS' QUARTERS



DECK 4
MAIN SHUTTLE BAY, UPPER PRIMARY CARGO BAYS, UPPER PHASER SUPPORT

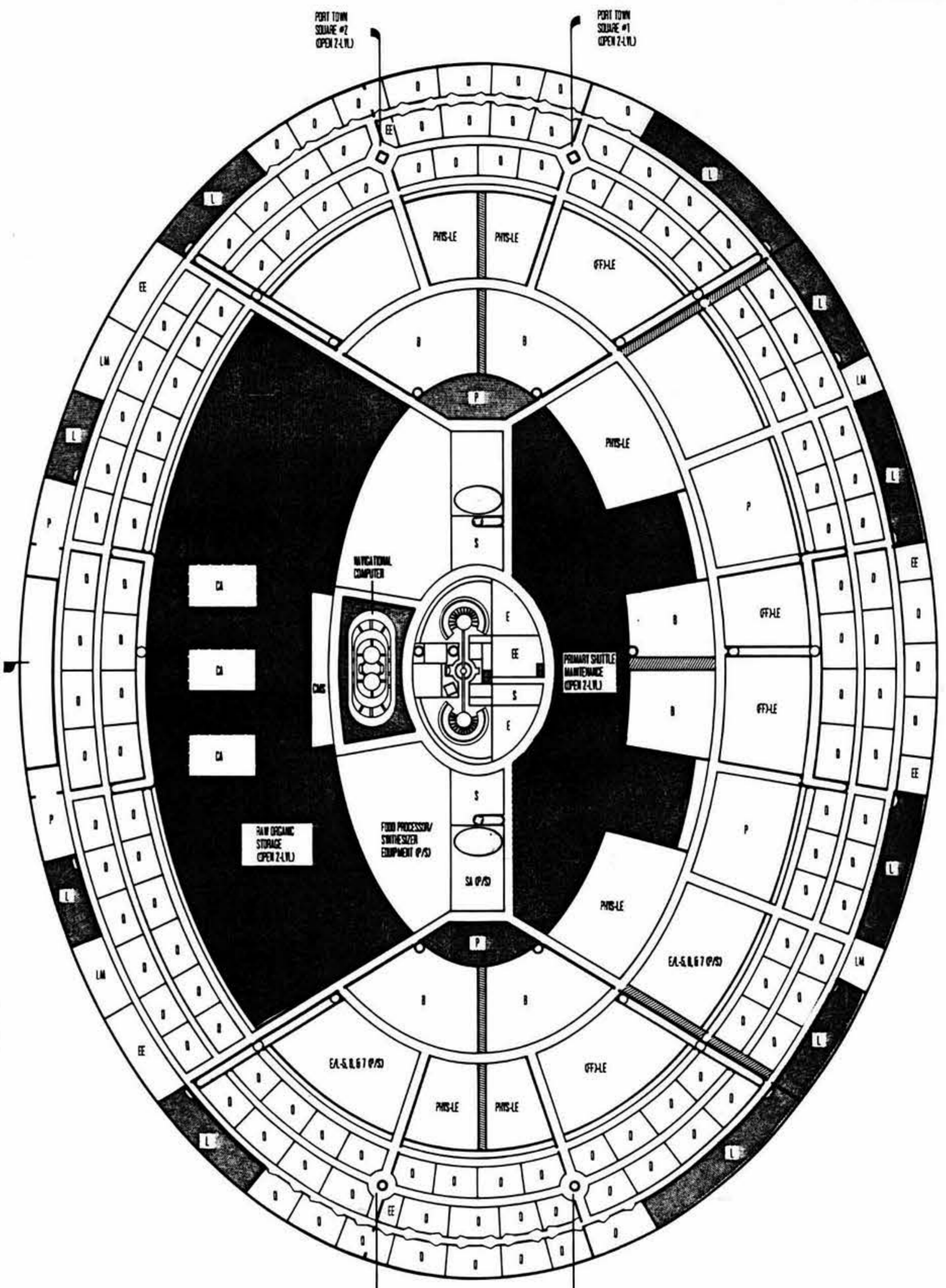
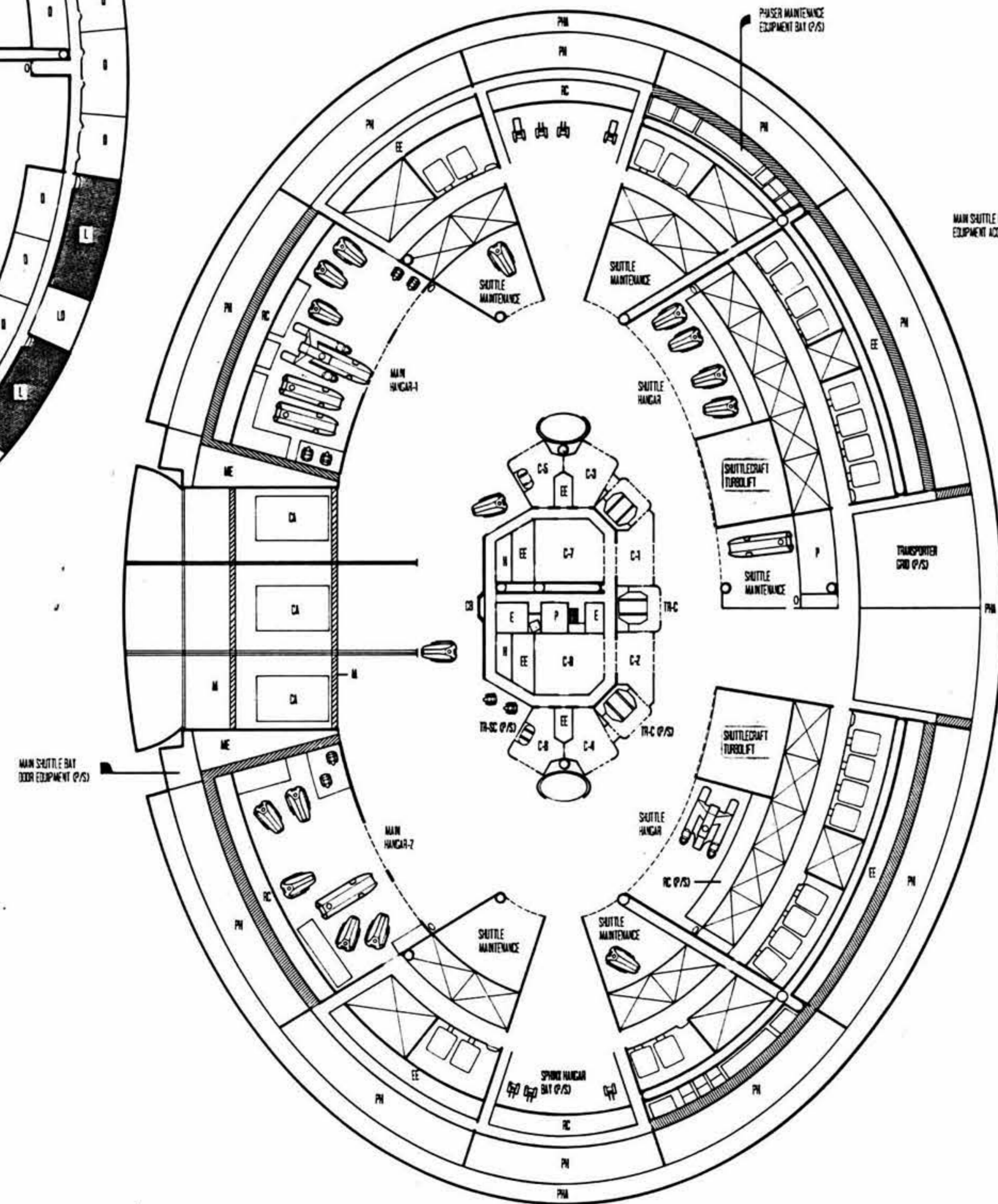

DECK 5
SCIENCE LABS, RESIDENTIAL APARTMENTS

		PROTOTYPE UPGRADE TO PRODUCTION STANDARDS
GALAXY NCC-1701-D MK. VII HEAVY CRUISER EDWIN LEE ZAMORA 40007 B 41789.3	U.S.S. ENTERPRISE - PRIMARY HULL - DECK 3 - DECK 4 - DECK 5	5 OF 13

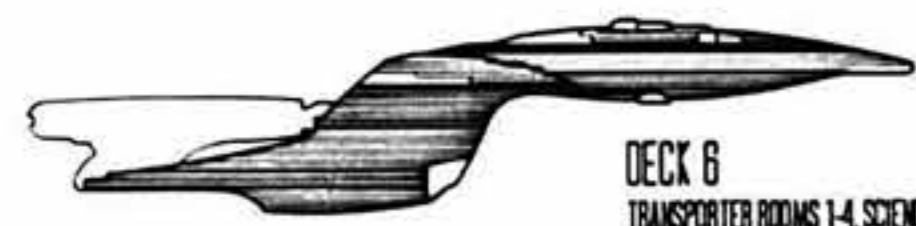
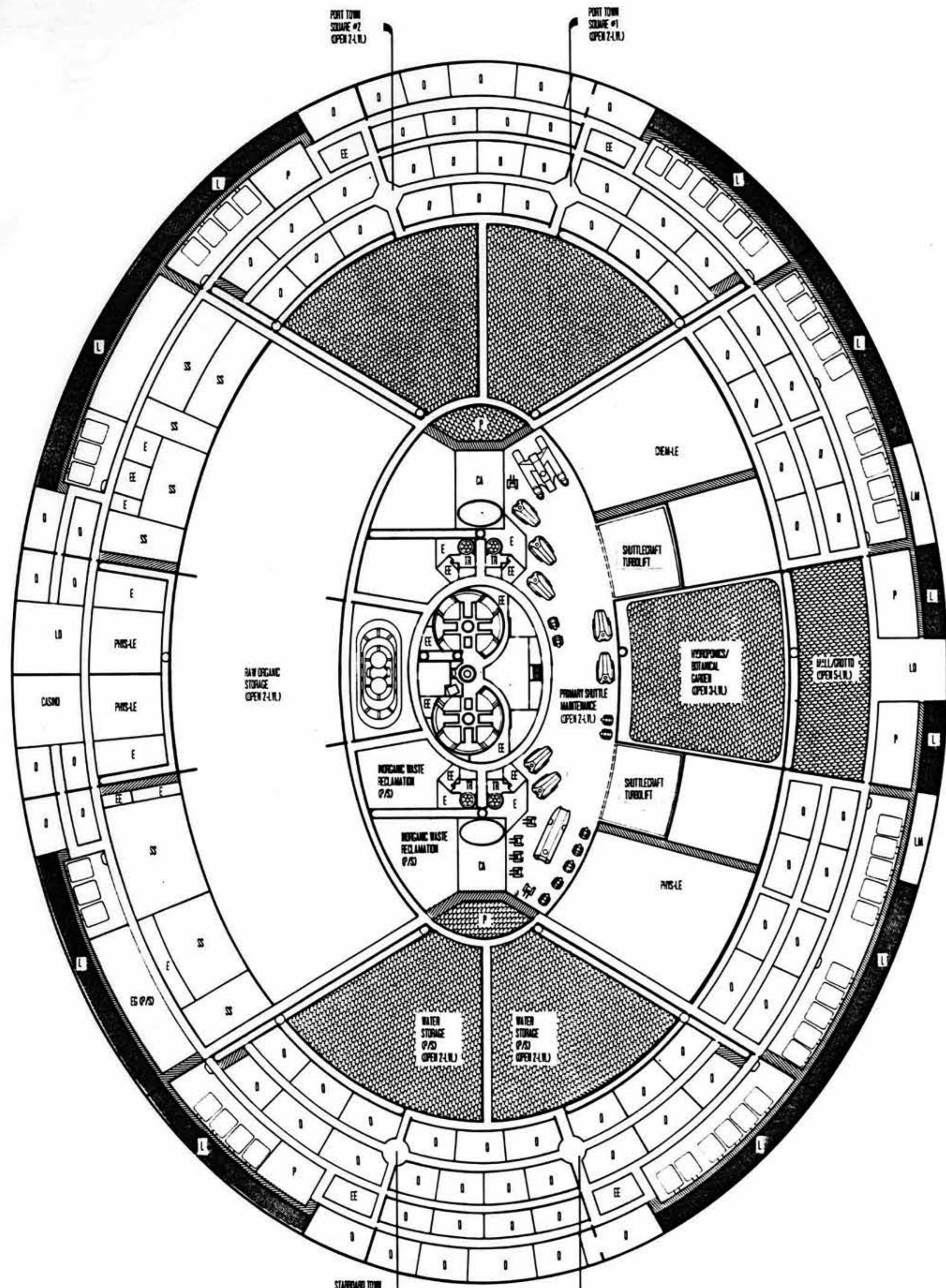

DECK 6
TRANSPORTER ROOMS 1-4, SCIENCE LABS, RESIDENTIAL APARTMENTS

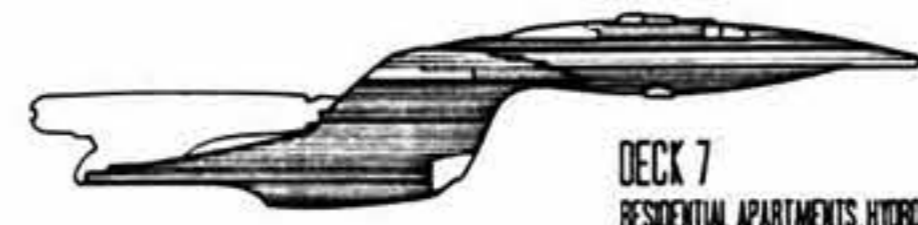
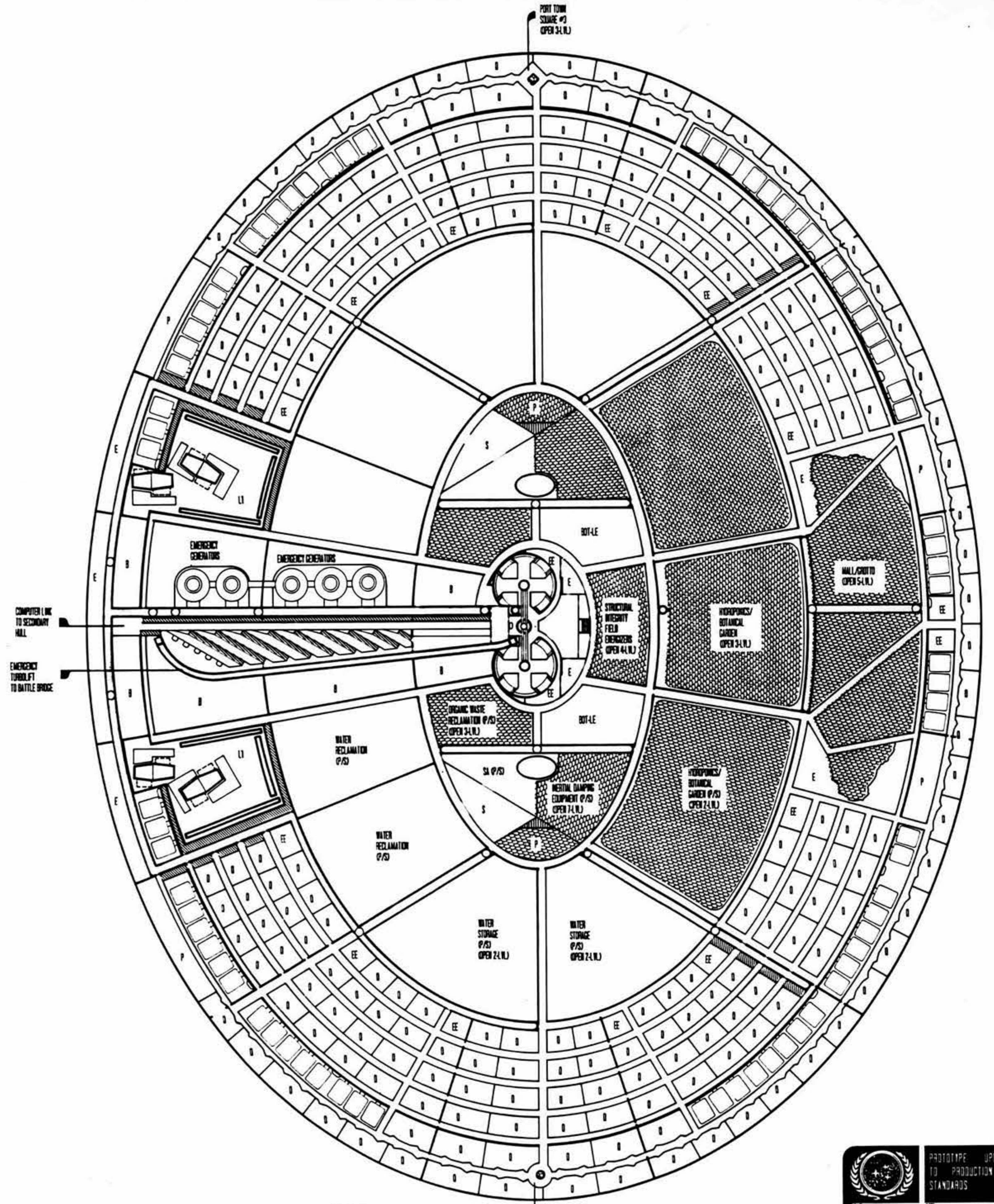

DECK 7
RESIDENTIAL APARTMENTS, HYDROPONICS, MAIN SECONDARY HALL ACCESS

		PROTOTYPE UPGRADE TO PRODUCTION STANDARDS
GALAXY NCC-1701-D MK. VII HEAVY CRUISER EDWIN LEE ZAMORA 400000 47880.2	U.S.S. ENTERPRISE - PRIMARY HULL - DECK 6 - DECK 7	8 OF 13

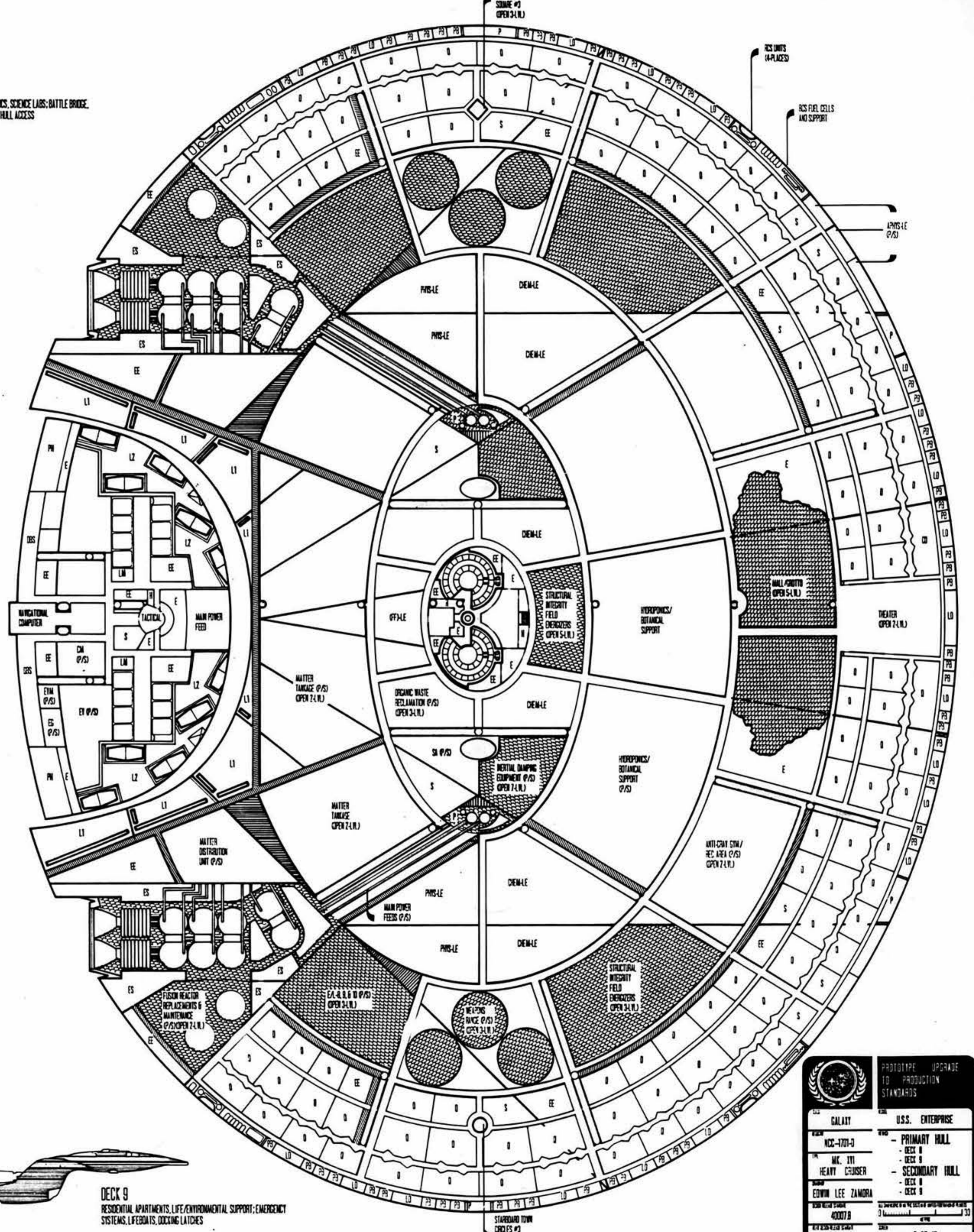
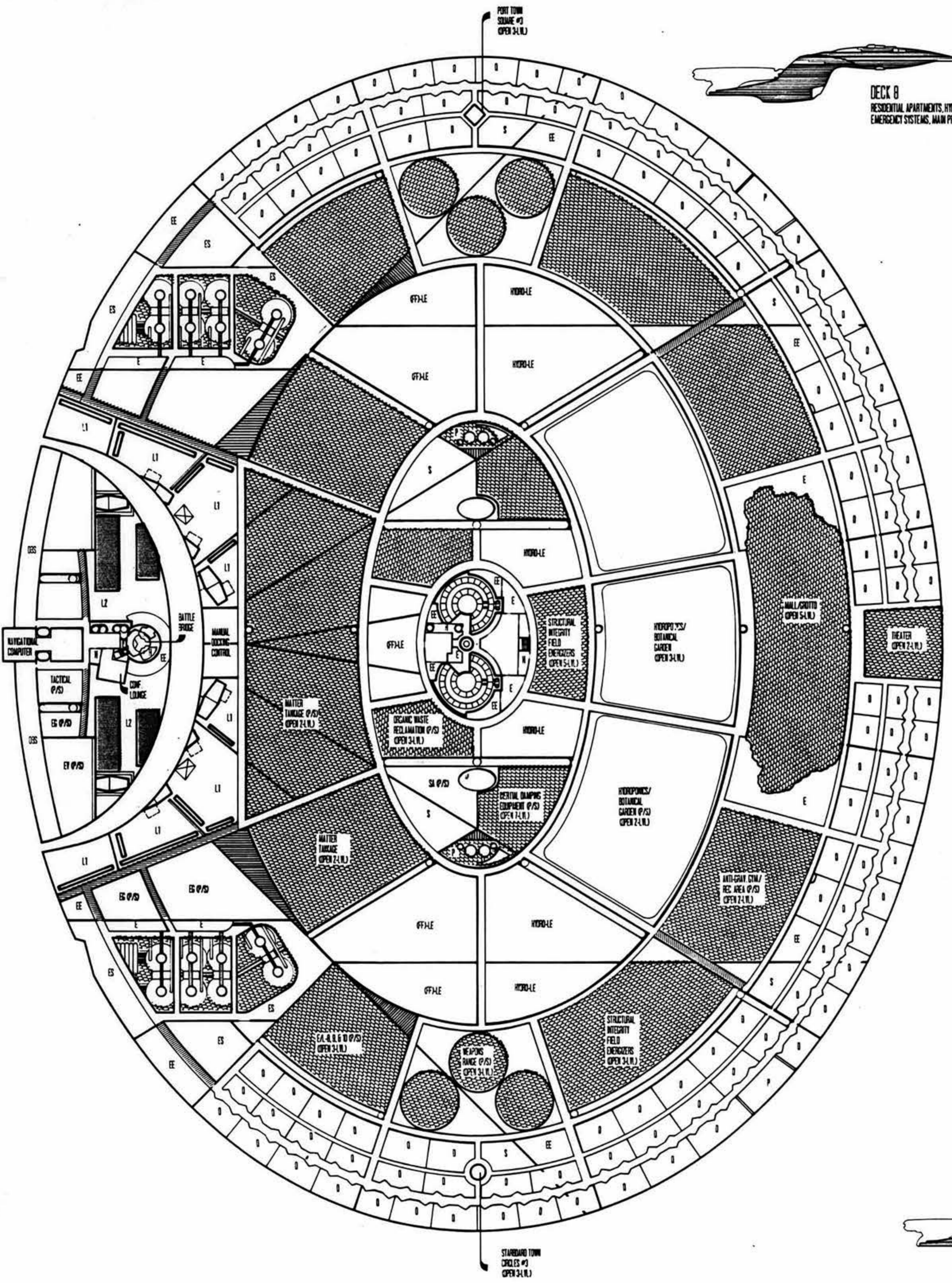

	PROTOTYPE	UPGRADE
	TO PRODUCTION	STANDARDS
CLASS: GALAXY	USS: ENTERPRISE	
NO: 1701-0	PRIMARY HULL	
MC: VII	DECK 8	
HEAVY CRUISER	SECONDARY HULL	
EDWIN LEE ZANDRA	DECK 9	
40007 B	DECK 0	
41789 C		
	7 OF 13	



DECK 10
TEN-FORWARD, COMPUTER CORE, LIFEBOATS, PRIMARY HULL ENGINEERING;
PHASER BANK SUPPORT, POWER BUS, EMERGENCY BATTERIES, DOCKING
LATCHES

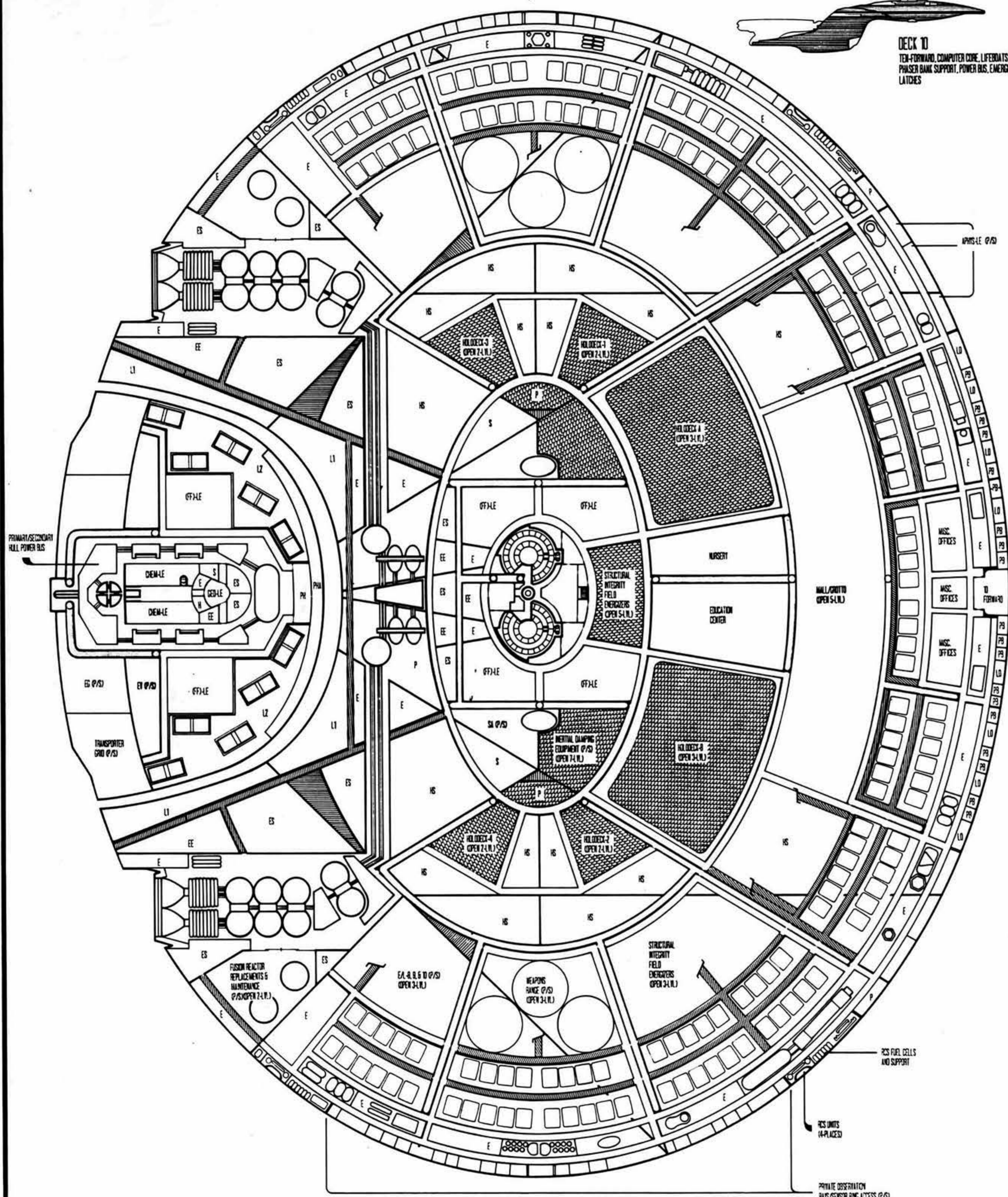

DECK 11
MAIN HOLDECKS, RESIDENTIAL APARTMENTS; LIFE/ENVIRONMENTAL
SUPPORT EQUIPMENT, SCIENCE LABS, DOCKING LATCHES

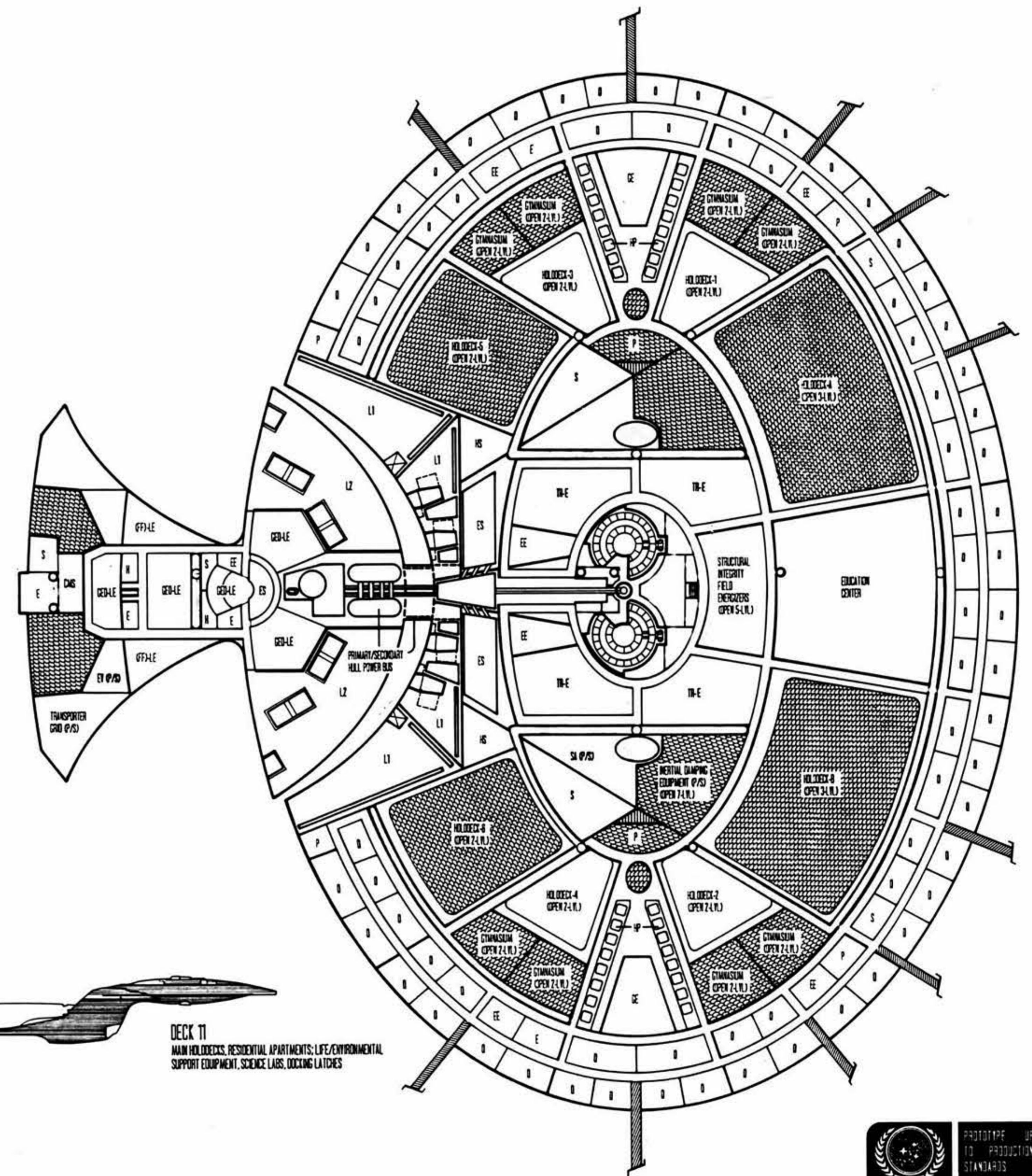

PROTOTYPE UPGRADE TO PRODUCTION STANDARDS	
CLASS: GALAXY MODEL: NX-7000 TYPE: MC. 171 HEAVY CRUISER DESIGNER: EDWIN LEE ZAMORA	CLASS: U.S.S. ENTERPRISE MODEL: NX-7000 TYPE: MC. 171 HEAVY CRUISER DESIGNER: EDWIN LEE ZAMORA
PLAN NO: 43377-B REV: 1/79	PLAN NO: 43377-B REV: 1/79
SHEET NO: 41789-B	SHEET NO: 8 OF 13

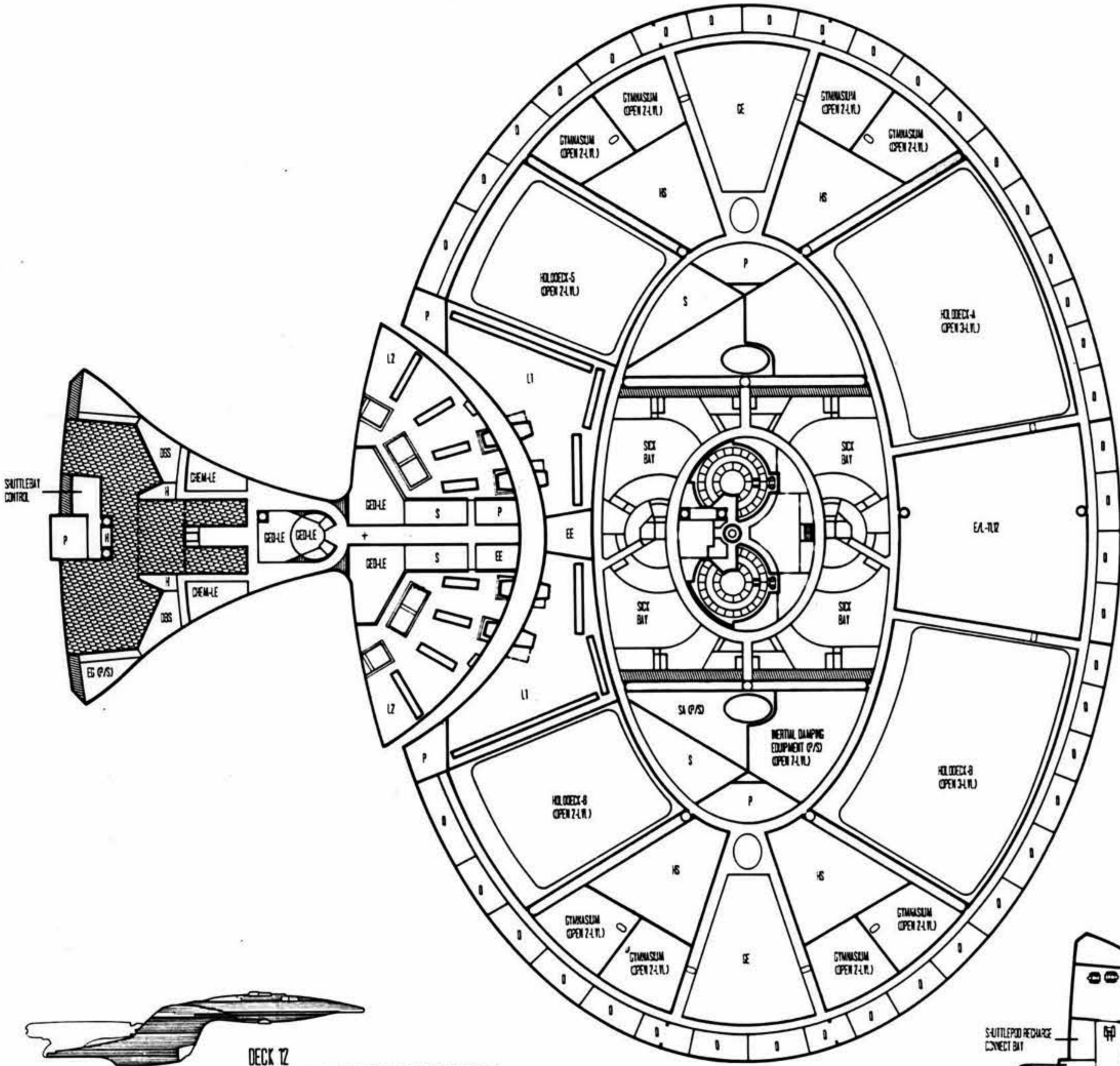

DECK 14
RESIDENTIAL APARTMENTS-TURSKIPS; SHUTTLE BAY SUPPORT,
TRANSPORTERS 5 & 6, DOCKING LATCHES

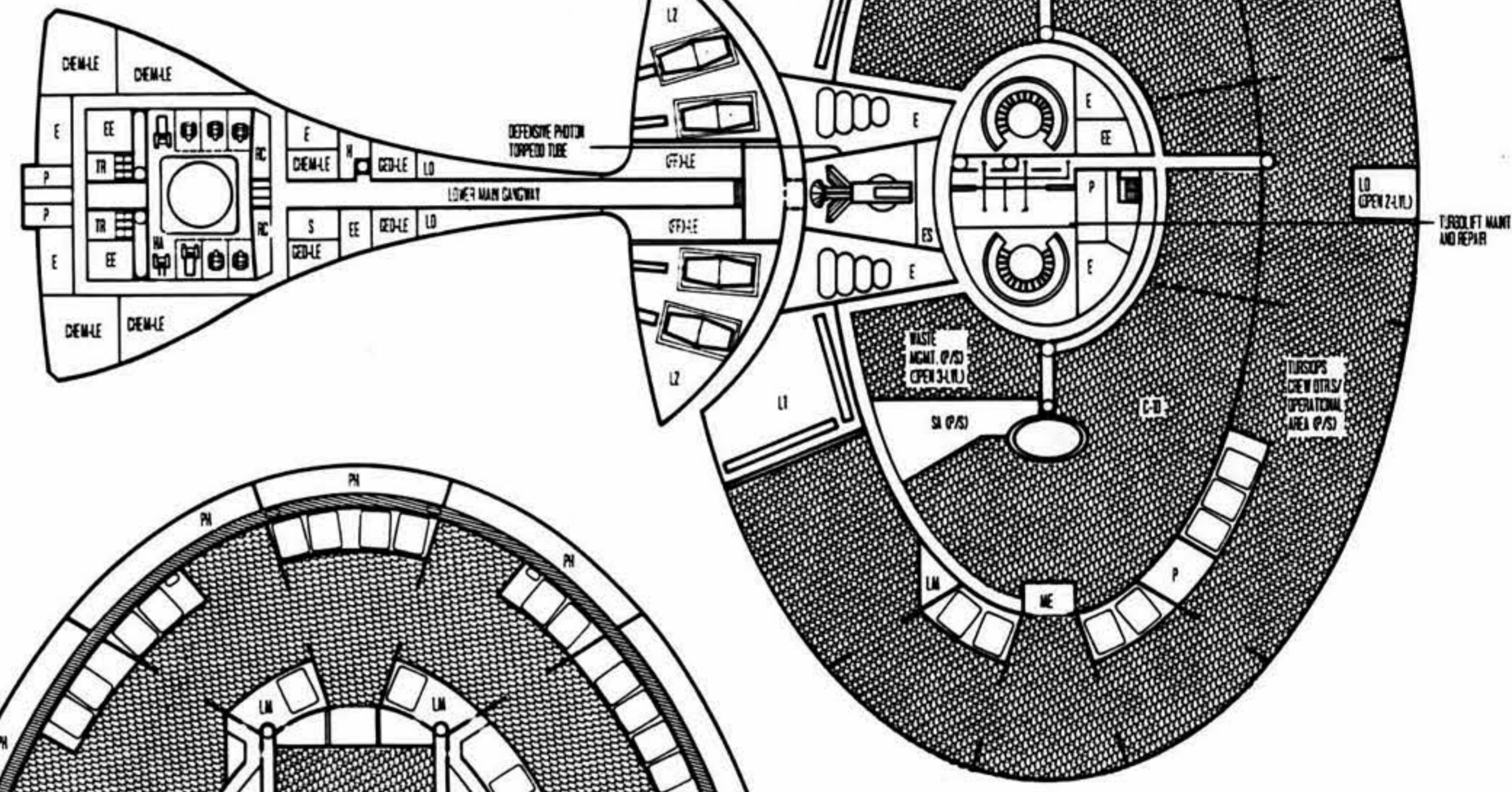

DECK 12
SICKBAY, STAMULUS, SECONDARY HOLD DECKS, RESIDENTIAL APARTMENTS;
SCIENCE LABS, DOCKING LATCHES



DECK 13
LIFE/ENVIRONMENTAL SUPPORT, LOWER PHASER SUPPORT; SHUTTLE BAYS
2 & 3, DOCKING LATCHES

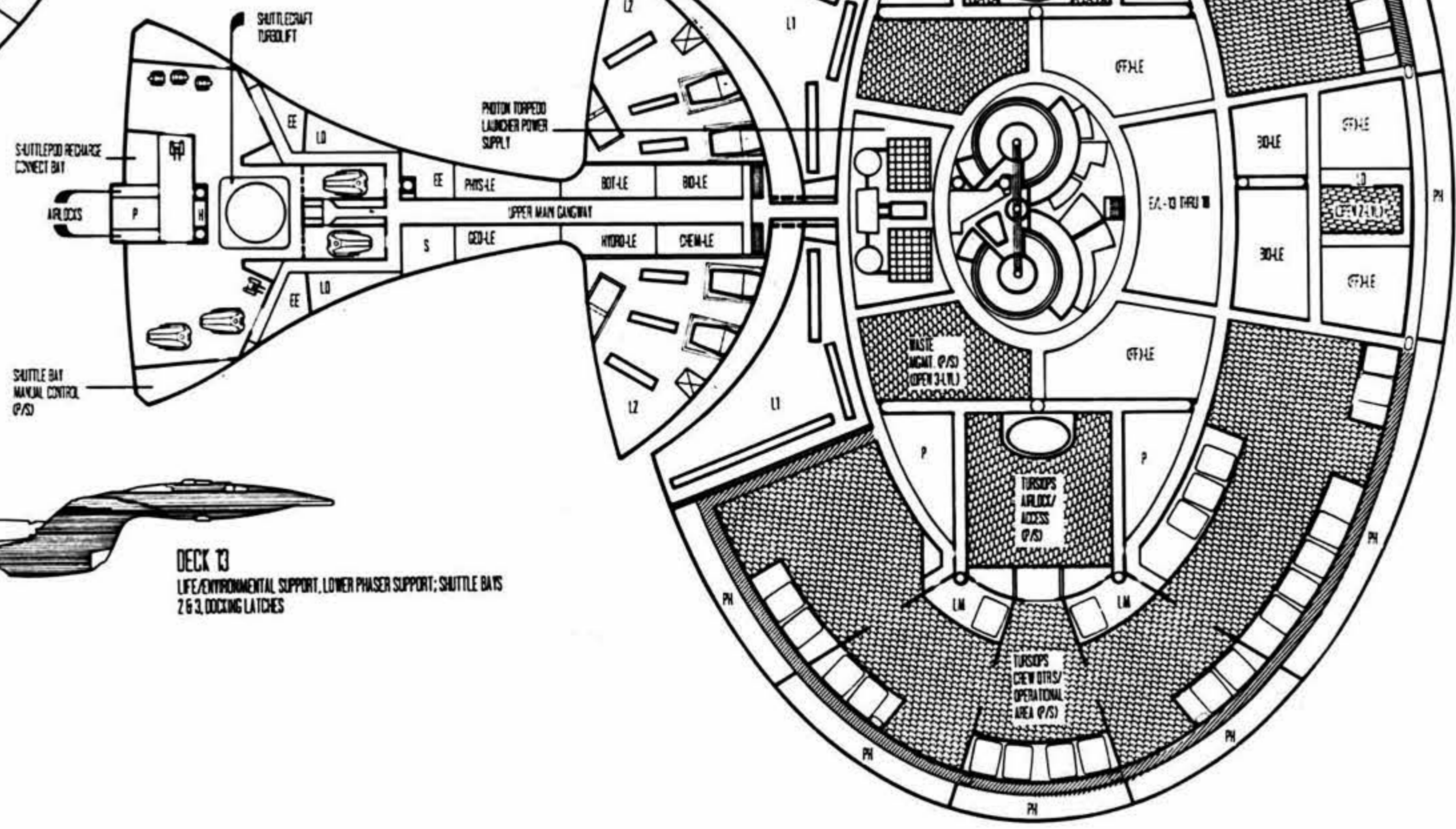

PROTOTYPE		UPGRADE TO PRODUCTION STANDARDS	
122	GALATT	122	U.S.S. ENTERPRISE
DESIGN	NCC-1701-D	DESIGN	- PRIMARY HULL
TYPE	MC. VII		- DECK 12 - DECK 14
	HEAVY CRUISER		- SECONDARY HULL
	EDWIN LEE ZAMORA		- DECK 12 - DECK 14
DESIGNER	400078	DESIGNER	400078
DATE	41789.3	DATE	8 OF 13

DECK 15
MAINTENANCE, LOWER PRIMARY CARGO BAYS, SCIENCE LABS

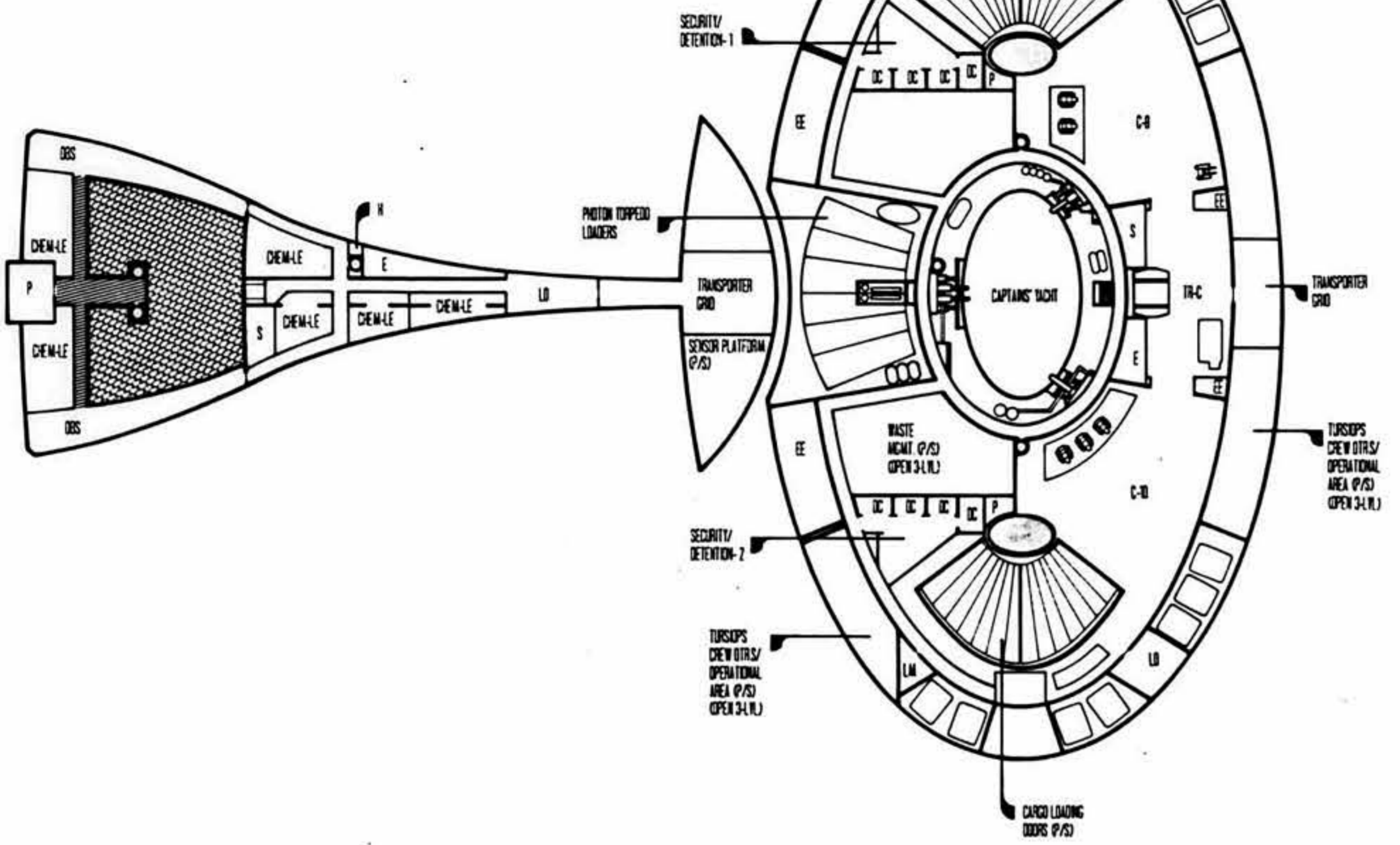

DECK 16
CAPTAIN'S YACHT; SHUTTLE MAINTENANCE

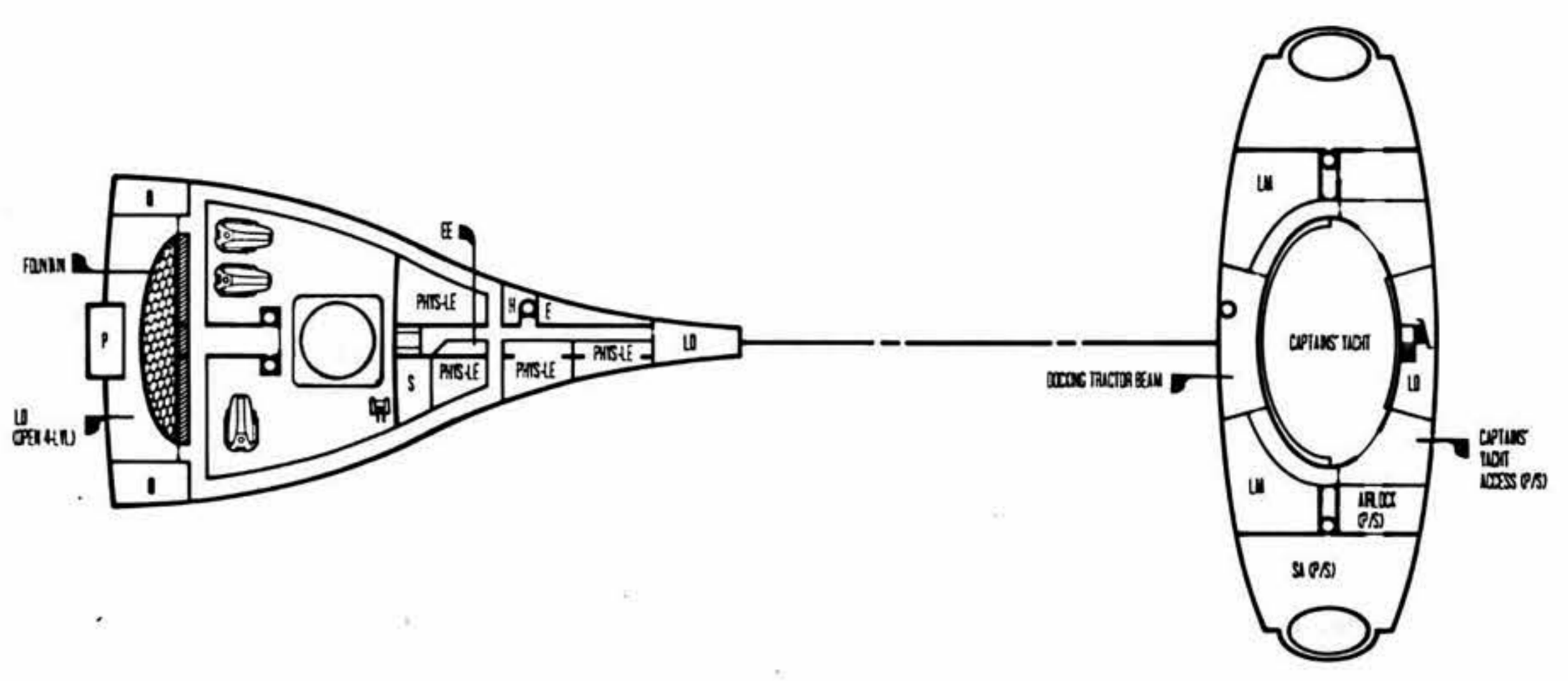

DECK 17
LIVING QUARTERS

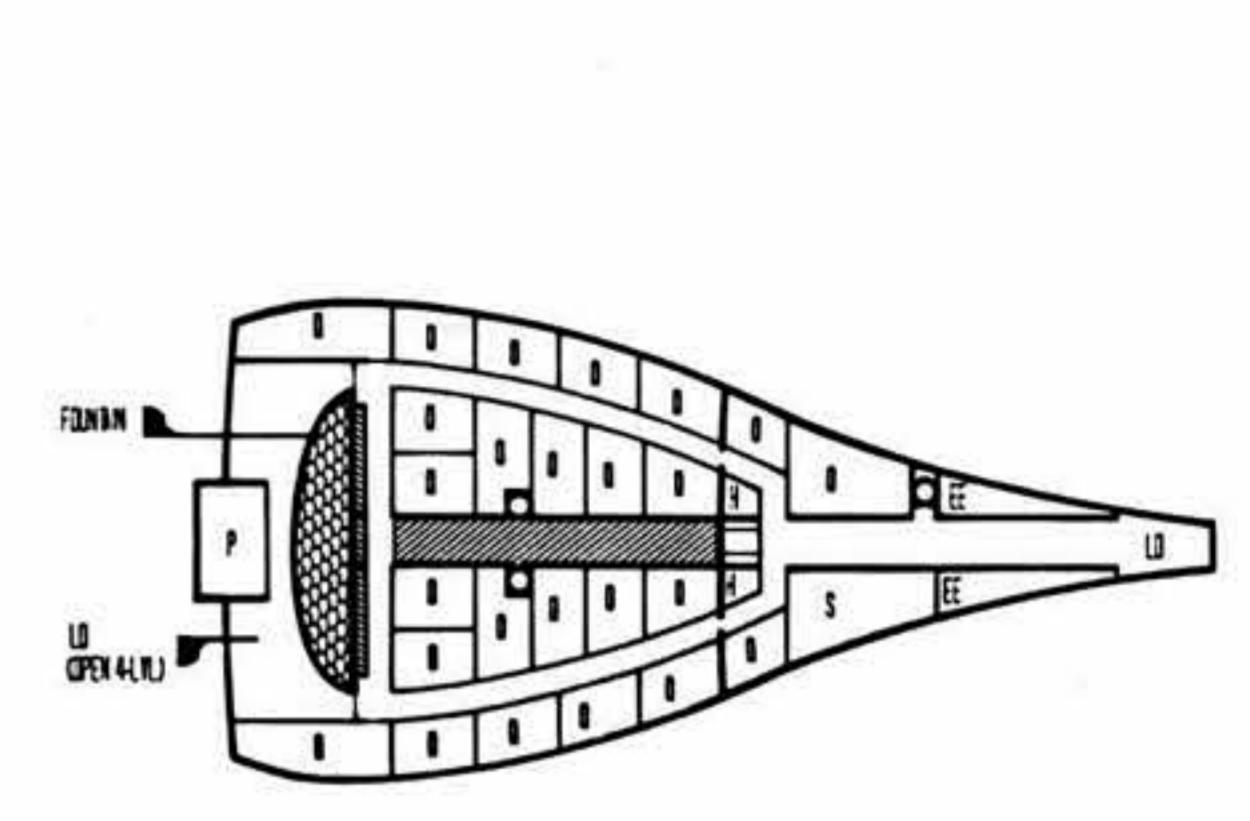

DECK 18
LIVING QUARTERS

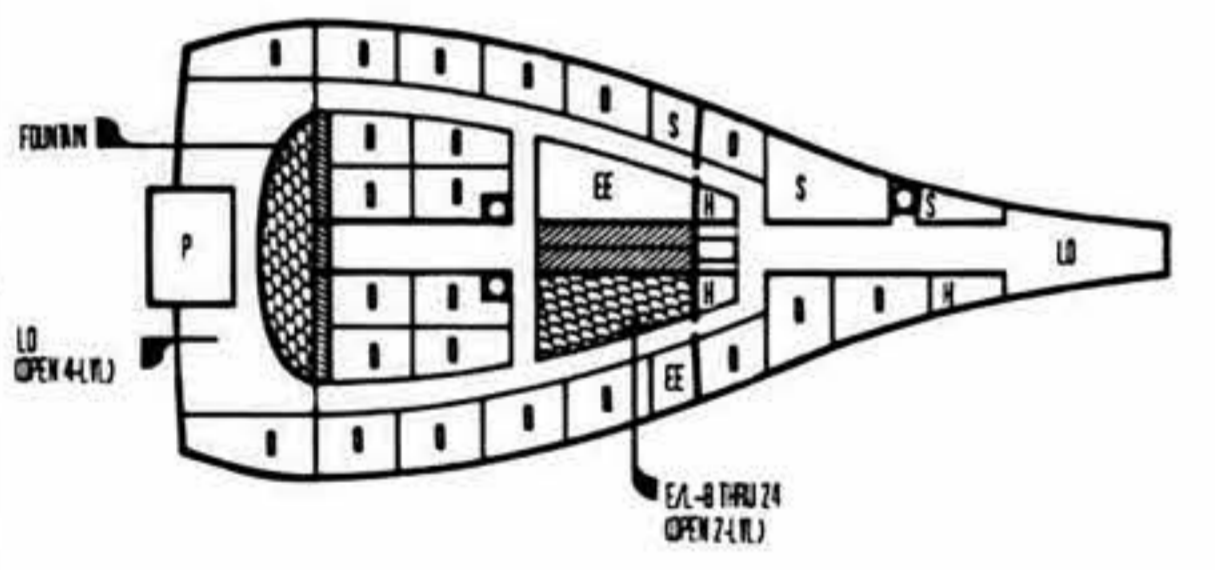

DECK 19
LIVING QUARTERS

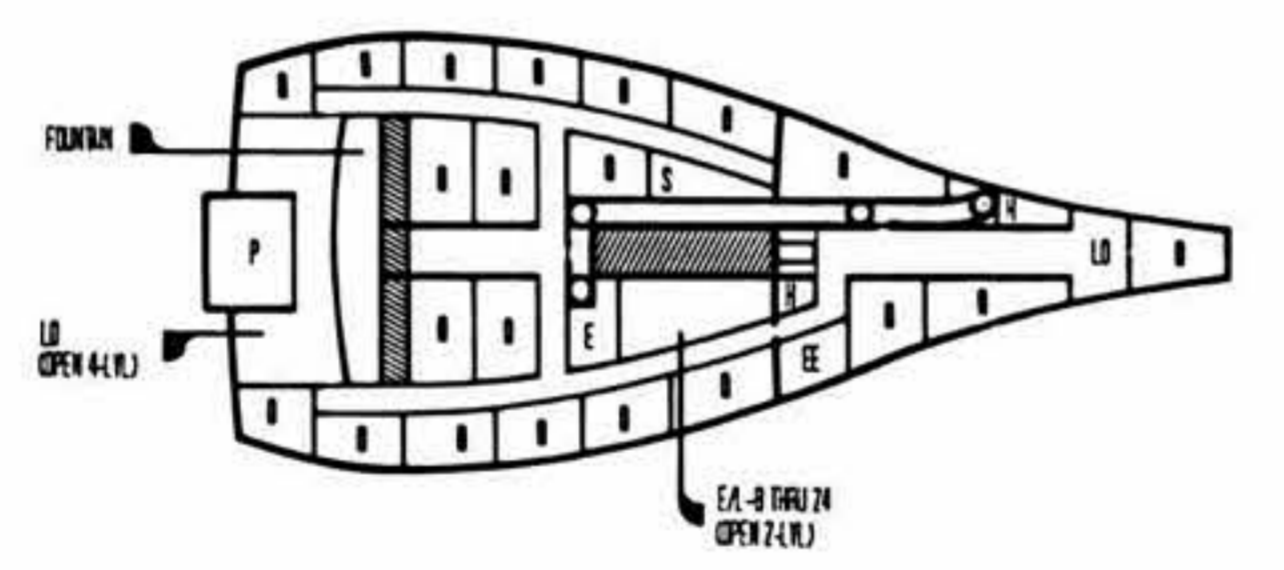

DECK 20
LIVING QUARTERS

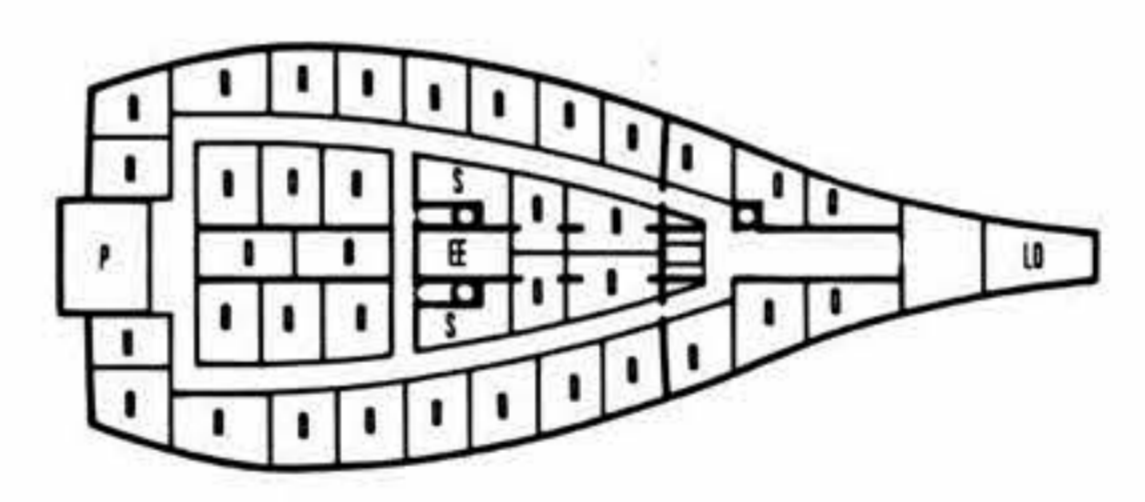

DECK 21
POWER DISTRIBUTION

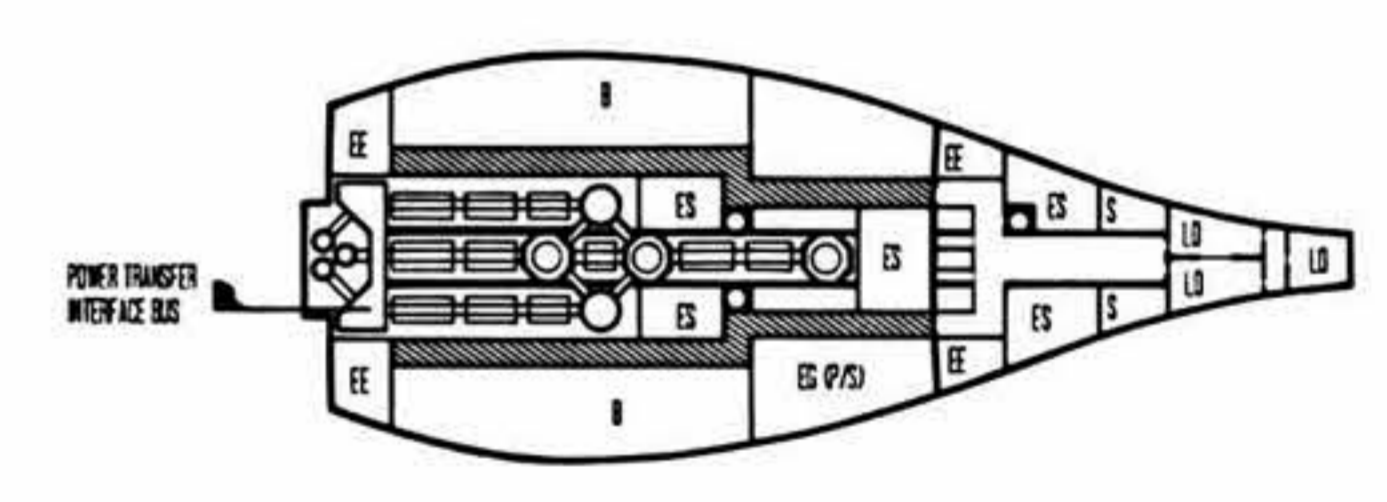

DECK 22
ENGINEERING SUPPORT

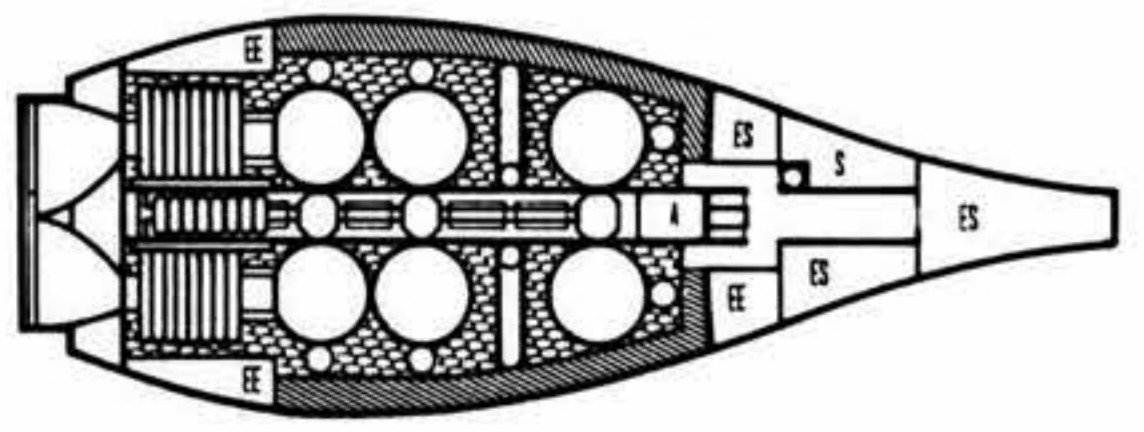

DECK 23
MAIN IMPULSE ENGINES

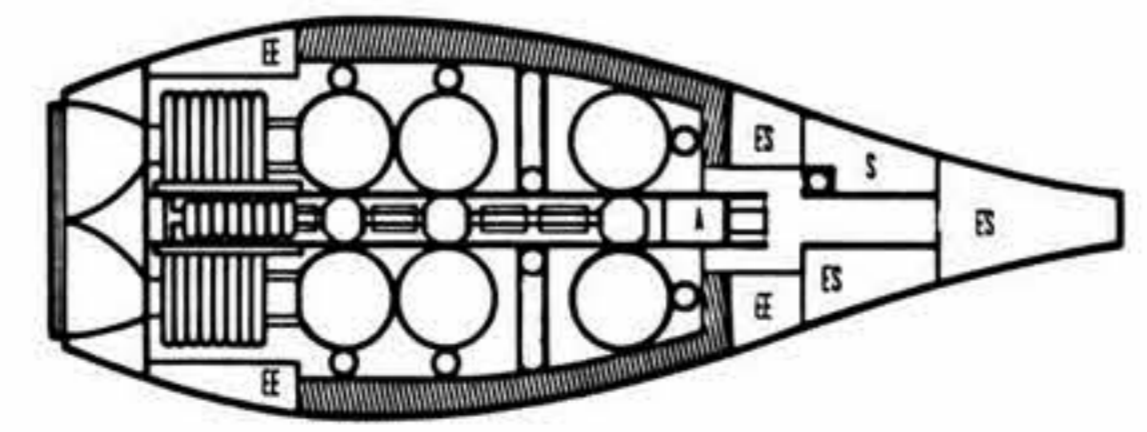

DECK 24
LIFE/ENVIRONMENTAL SUPPORT

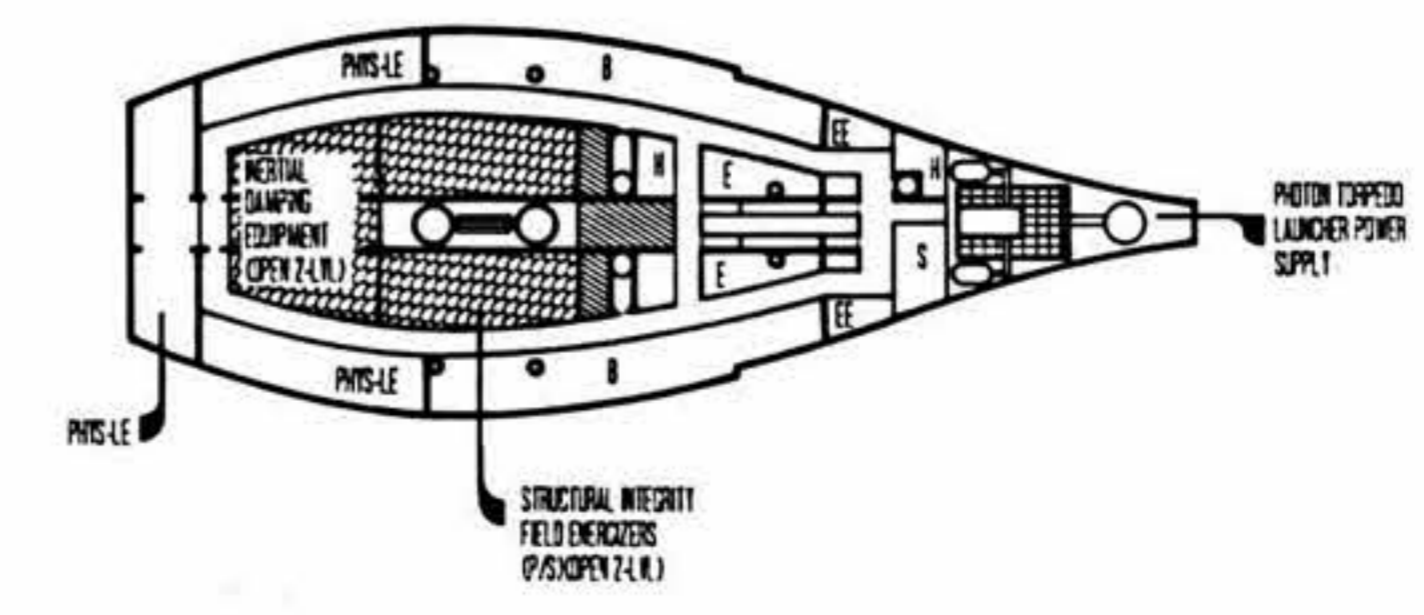

DECK 25
TORPEDO/PROBE LAUNCHER, MAIN DOCKING PORT, LIFE/ENVIRONMENTAL SUPPORT

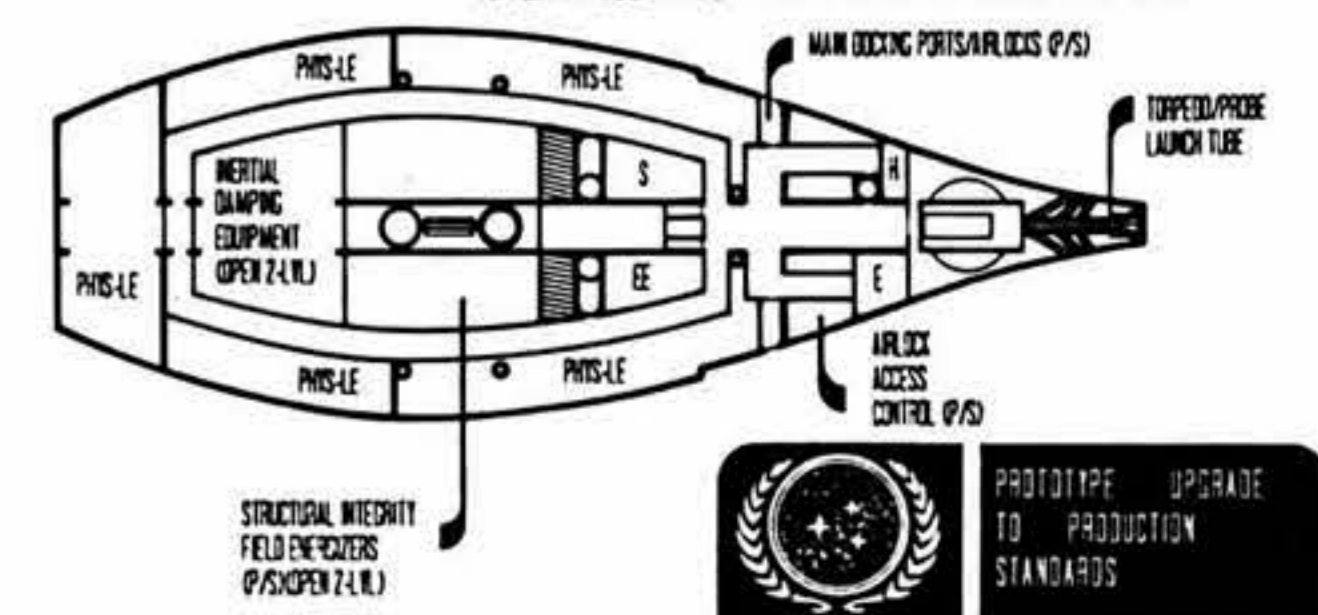

		PROTOTYPE	UPGRADE
		STANDARDS	STANDARDS
CLASS	GALAXY	CLASS	U.S.S. ENTERPRISE
DESIGN	NCC-1701-D	DESIGN	PRIMARY HULL - DECK 15 SECONDARY HULL - DECK 16
TYPE	MC. XII HEAVY CRUISER	TYPE	DECK 15 - DECK 16 - DECK 23 DECK 17 - DECK 18 - DECK 24 DECK 19 - DECK 21 - DECK 25
DESIGNER	EDWIN LEE ZAMORA	DESIGNER	DECK 17 - DECK 21 - DECK 25

DECK HULL NUMBER: 40307-D
 DECK HULL NUMBER: 41788-D
 ALL DIMENSIONS IN METERS UNLESS OTHERWISE SPECIFIED IN PARENTS.
 SCALE: 1:1000
 DATE: 10 OF 13

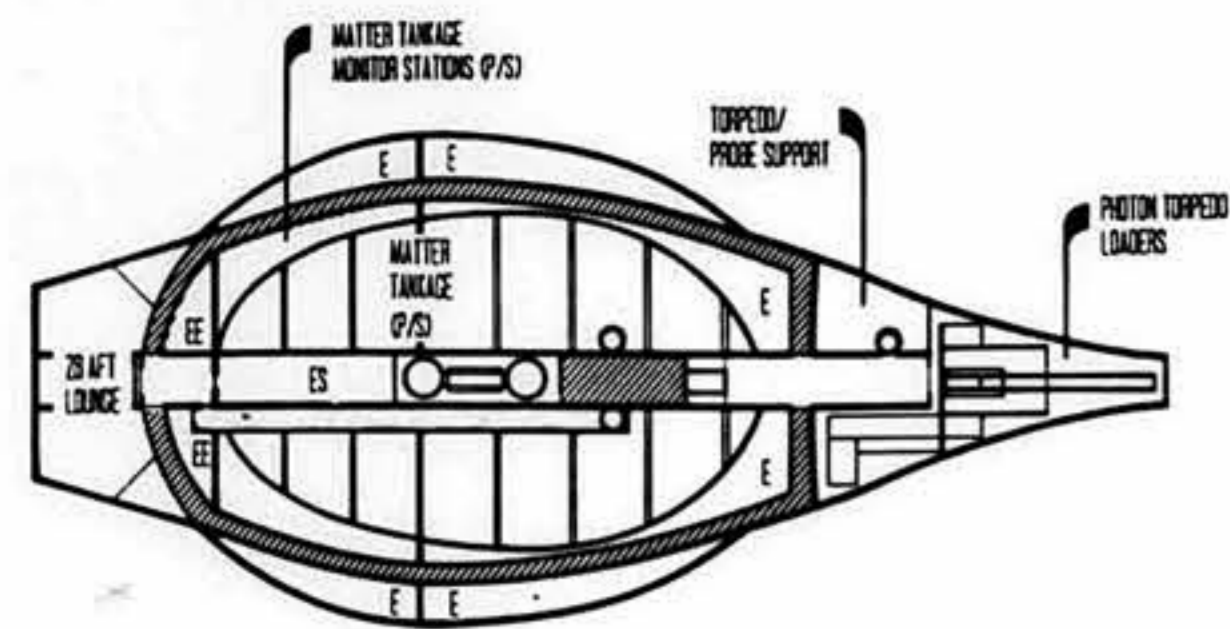

DECK 26
DEUTERIUM HYDROGEN FUEL STORAGE

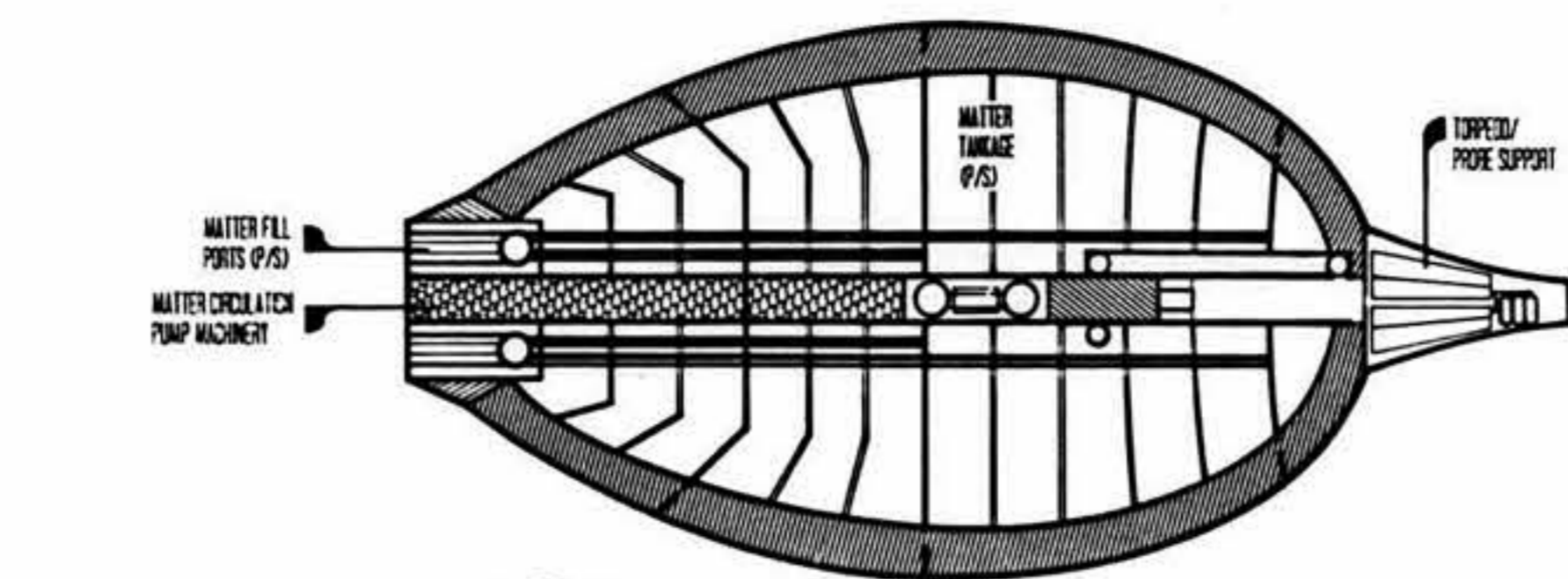

DECK 27
DEUTERIUM HYDROGEN FUEL STORAGE, CIRCULATION PUMPS, FILL PORTS

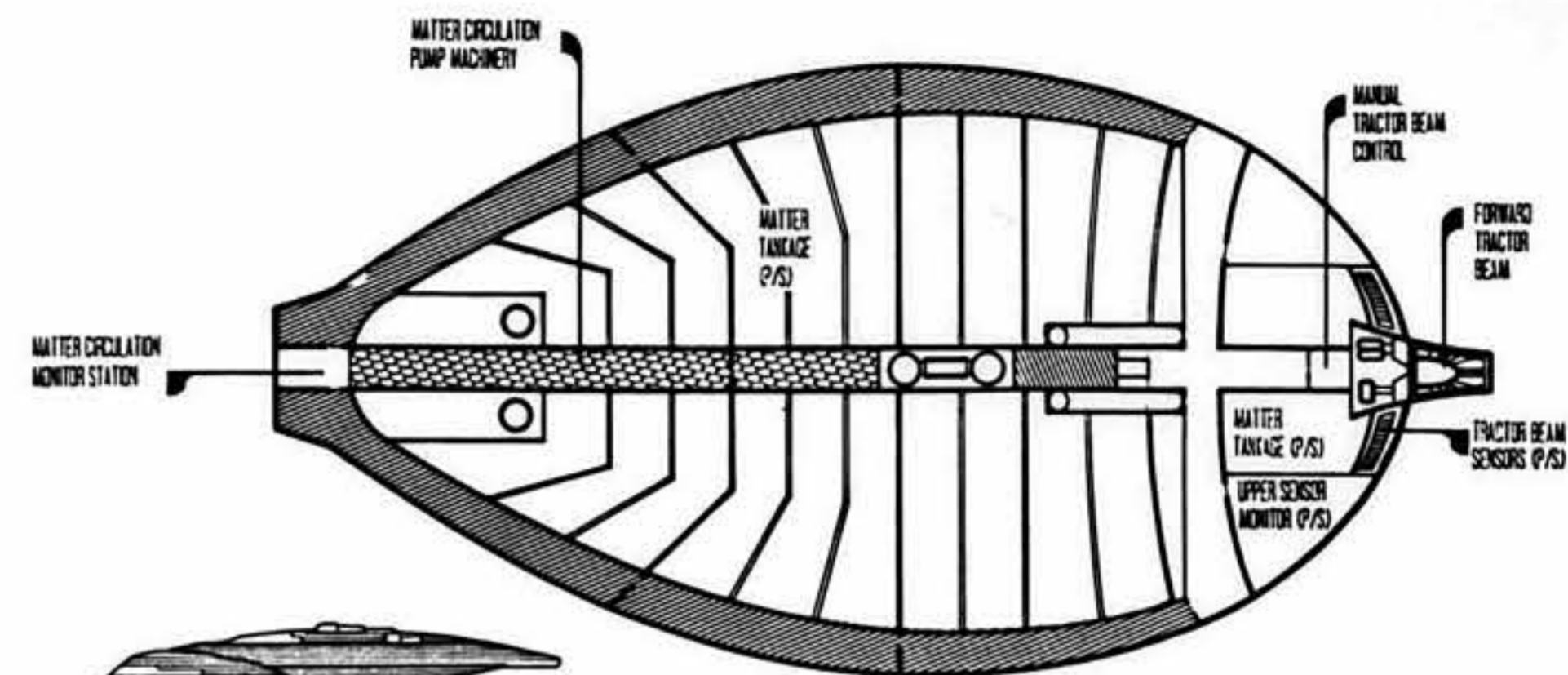

DECK 28
DEUTERIUM HYDROGEN FUEL STORAGE, CIRCULATION PUMPS

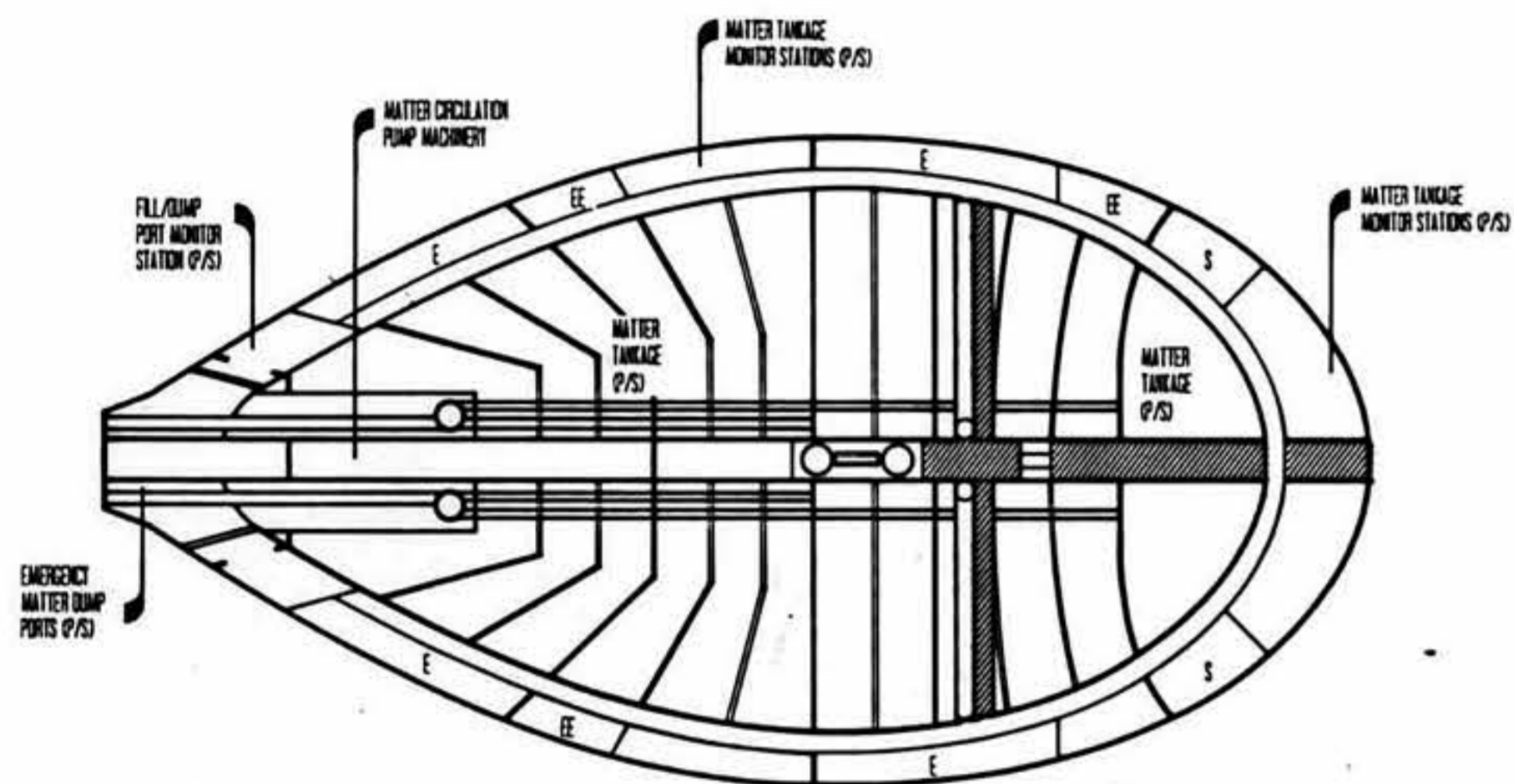

DECK 29
DEUTERIUM HYDROGEN FUEL STORAGE, DUMP PORTS, INJECTION REACTORS

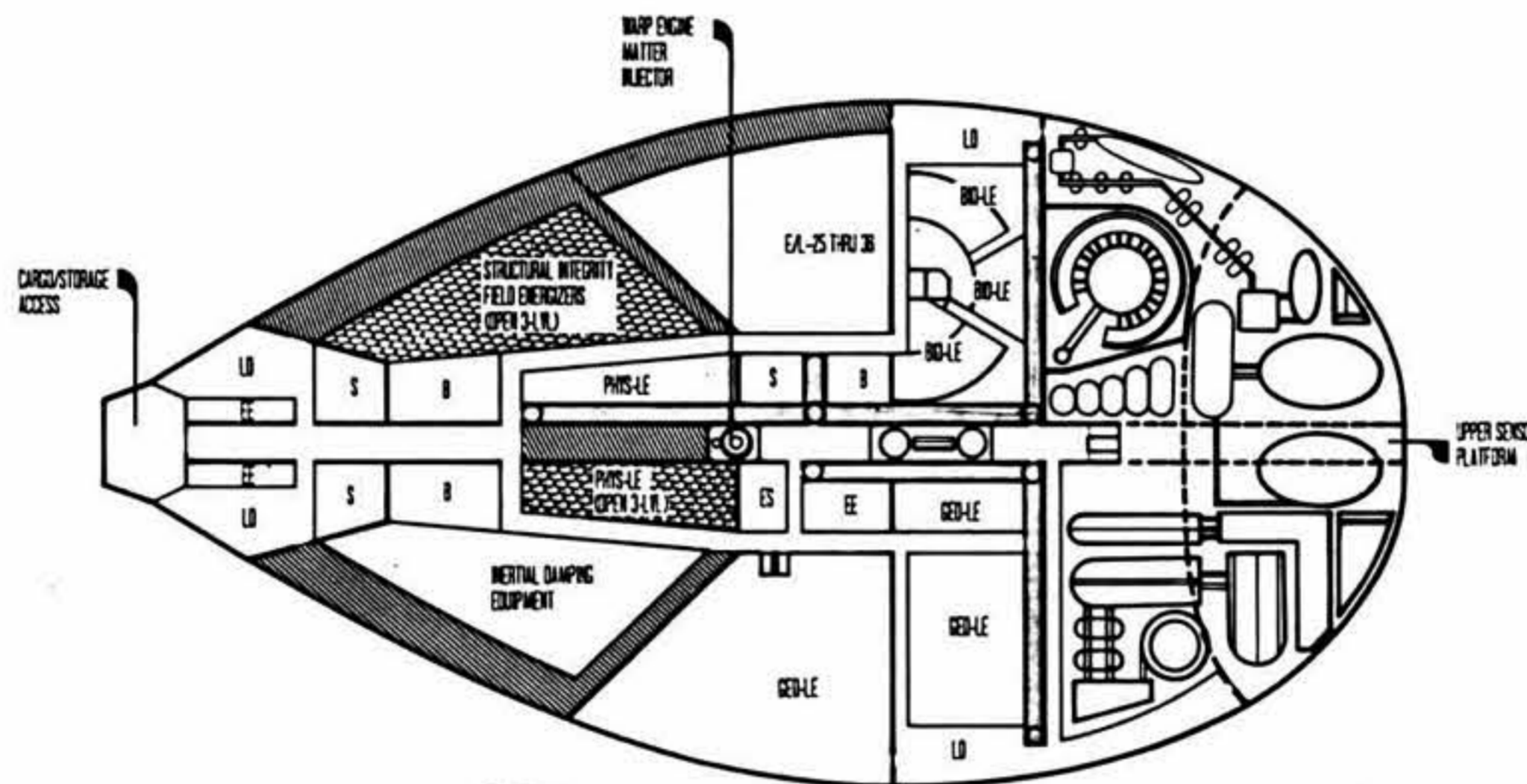

DECK 30
UPPER SENSOR PLATFORM, SCIENCE LABS

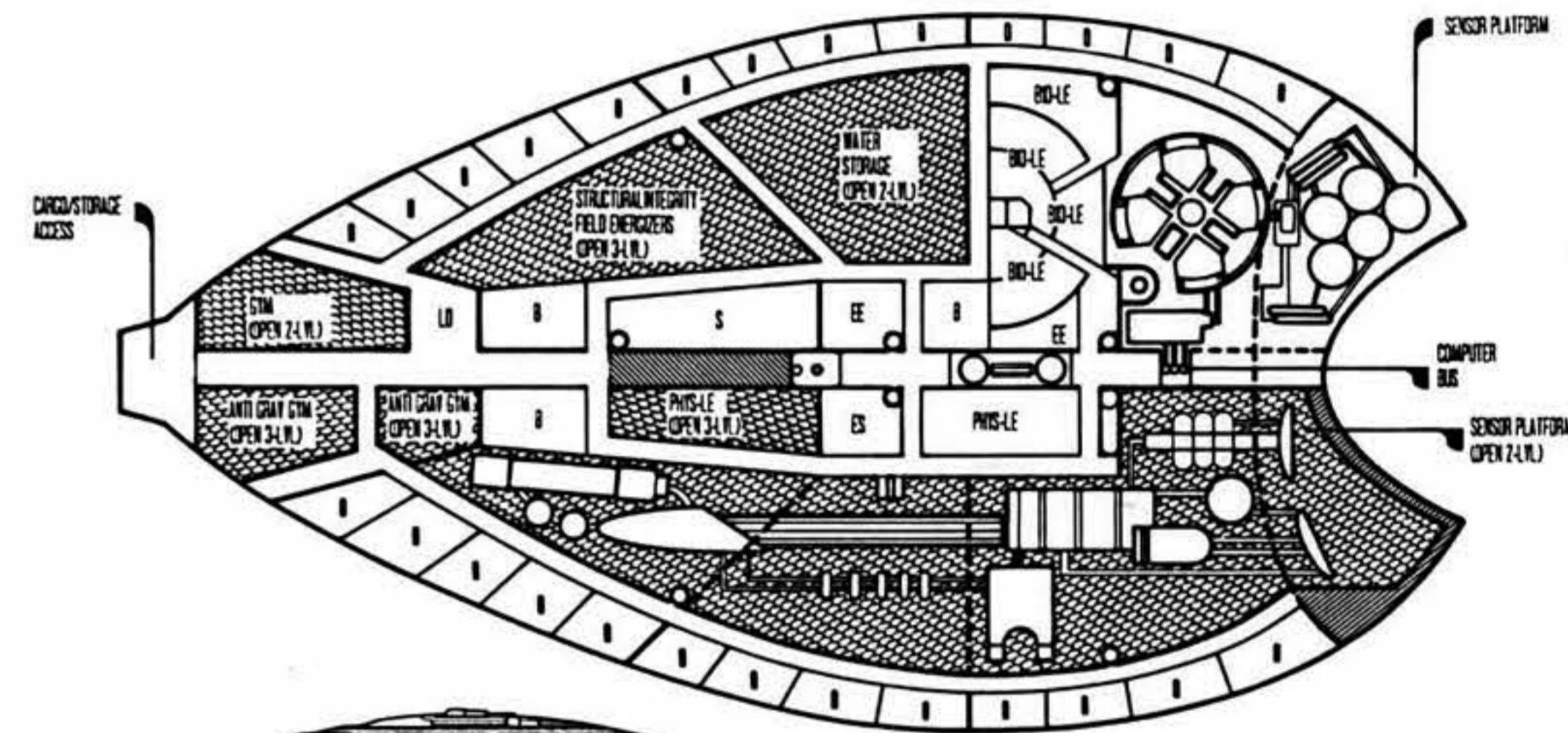

DECK 31
SCIENCE LABS, SENSORS

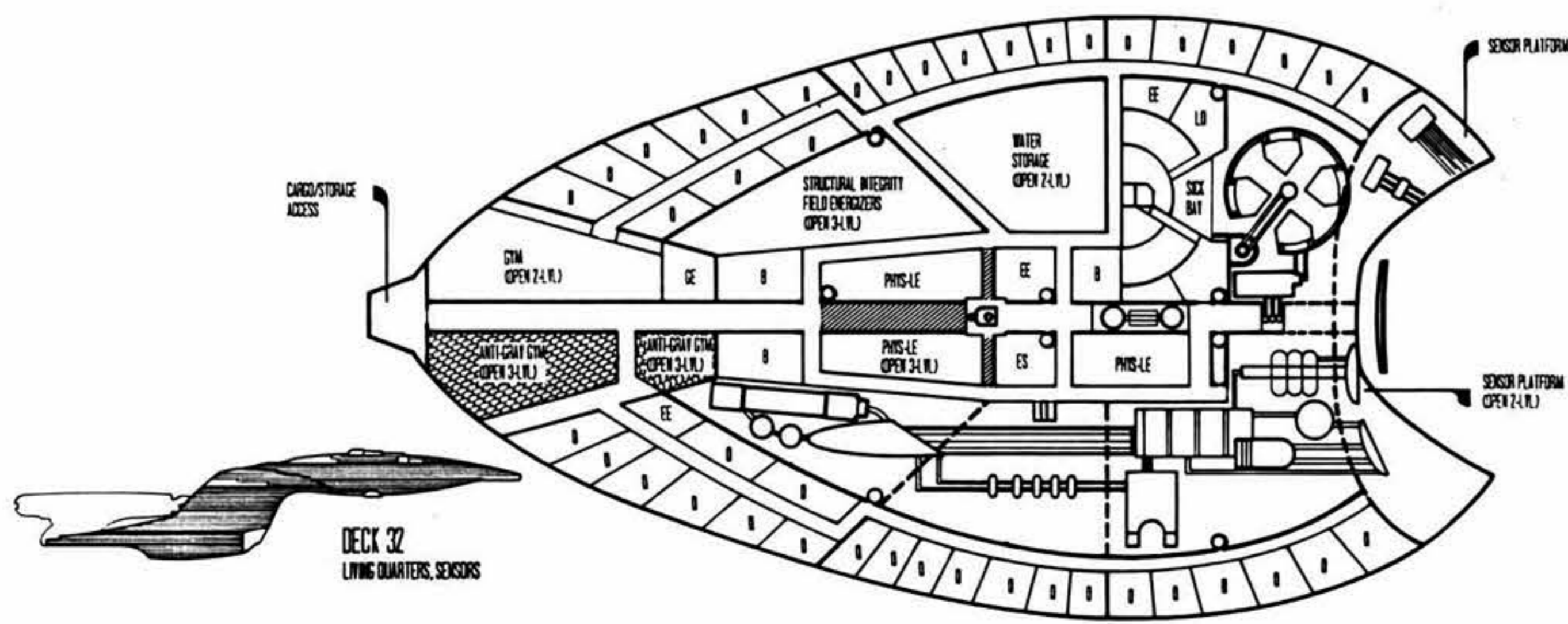

DECK 32
LIVING QUARTERS, SENSORS

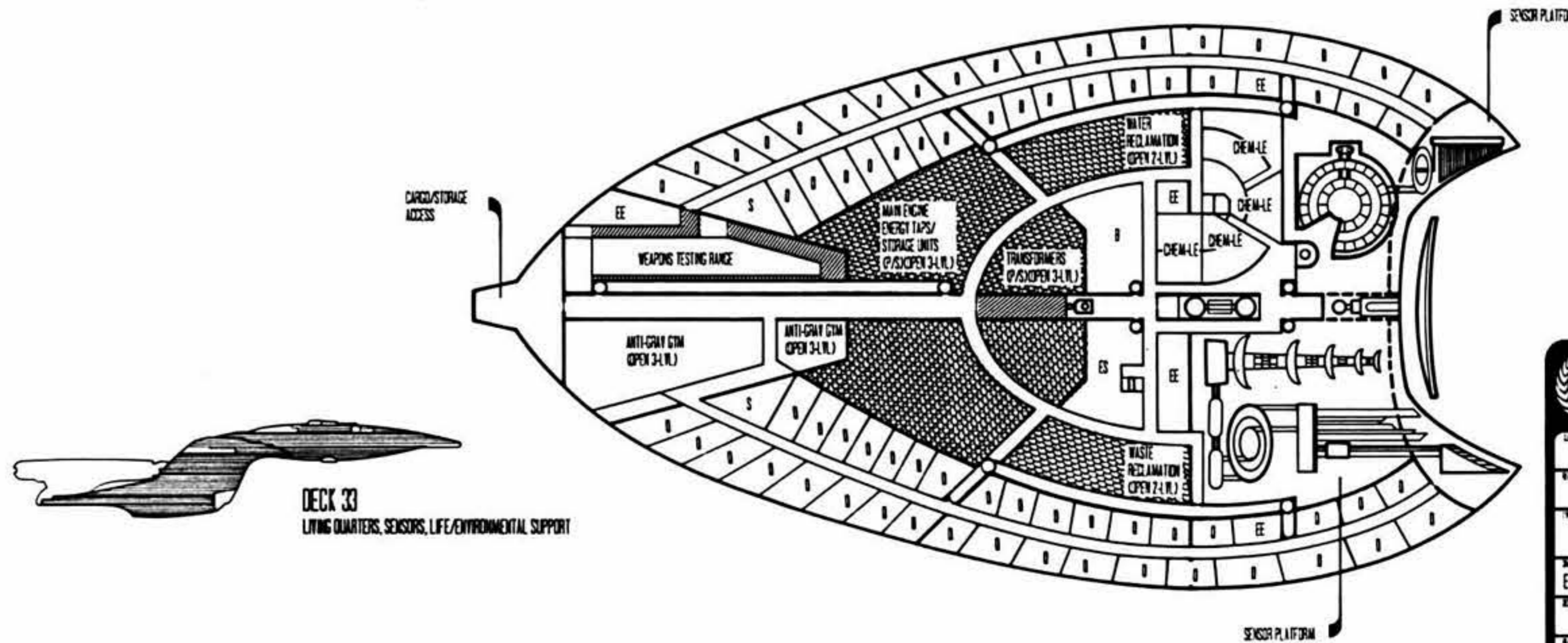

DECK 33
LIVING QUARTERS, SENSORS, LIFE/ENVIRONMENTAL SUPPORT

		PROTOTYPE UPGRADE TO PRODUCTION STANDARDS
CLASS: GALAXY MODEL: NCC-1701-D TYPE: MC. TYP HEAVY CRUISER CAPTAIN: EDWIN LEE ZAMORA CREW: 400078 REG. NO.: 417892	U.S.S. ENTERPRISE TYPE: SECONDARY HULL DECKS: DECK 26 - DECK 30 DECK 27 - DECK 31 DECK 28 - DECK 32 DECK 29 - DECK 33	
11 OF 13		

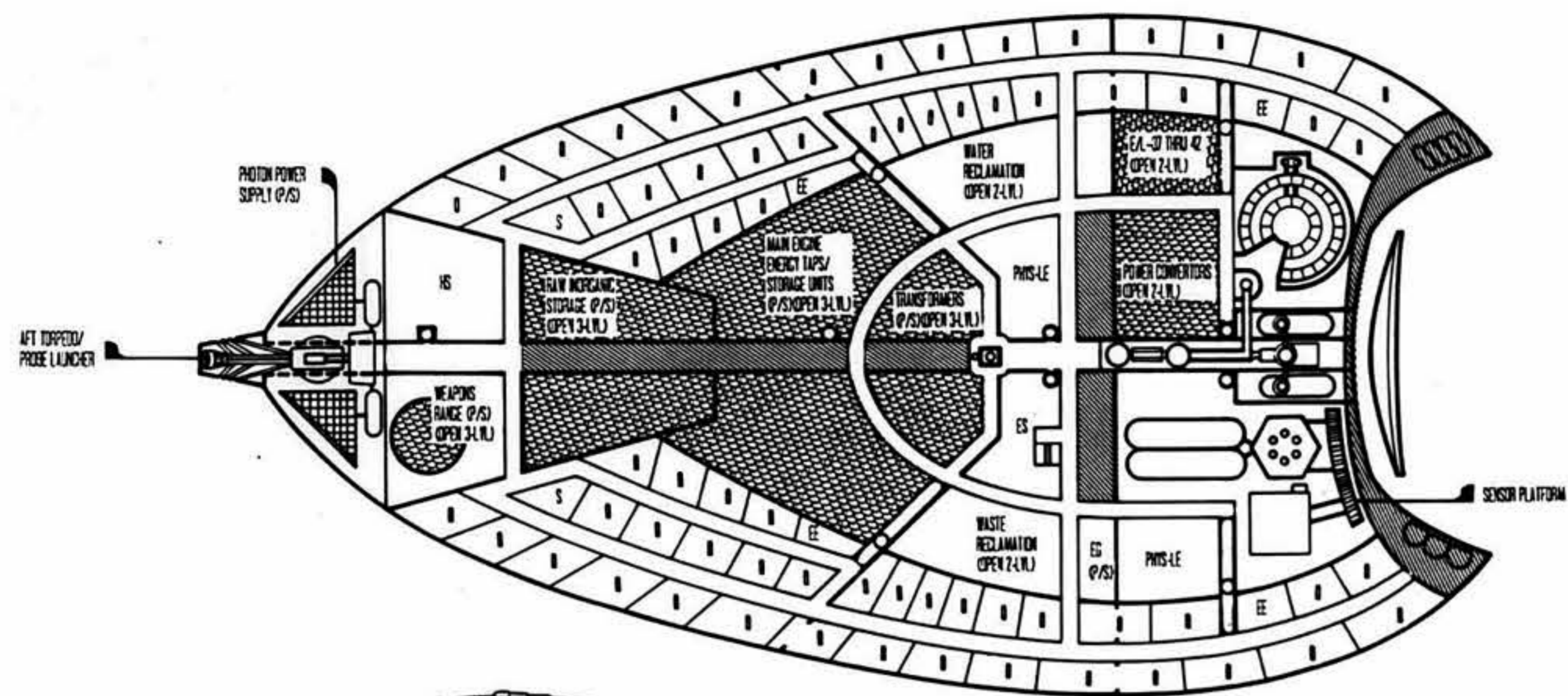

DECK 34
LIVING QUARTERS, SENSORS, LIFE/ENVIRONMENTAL SUPPORT

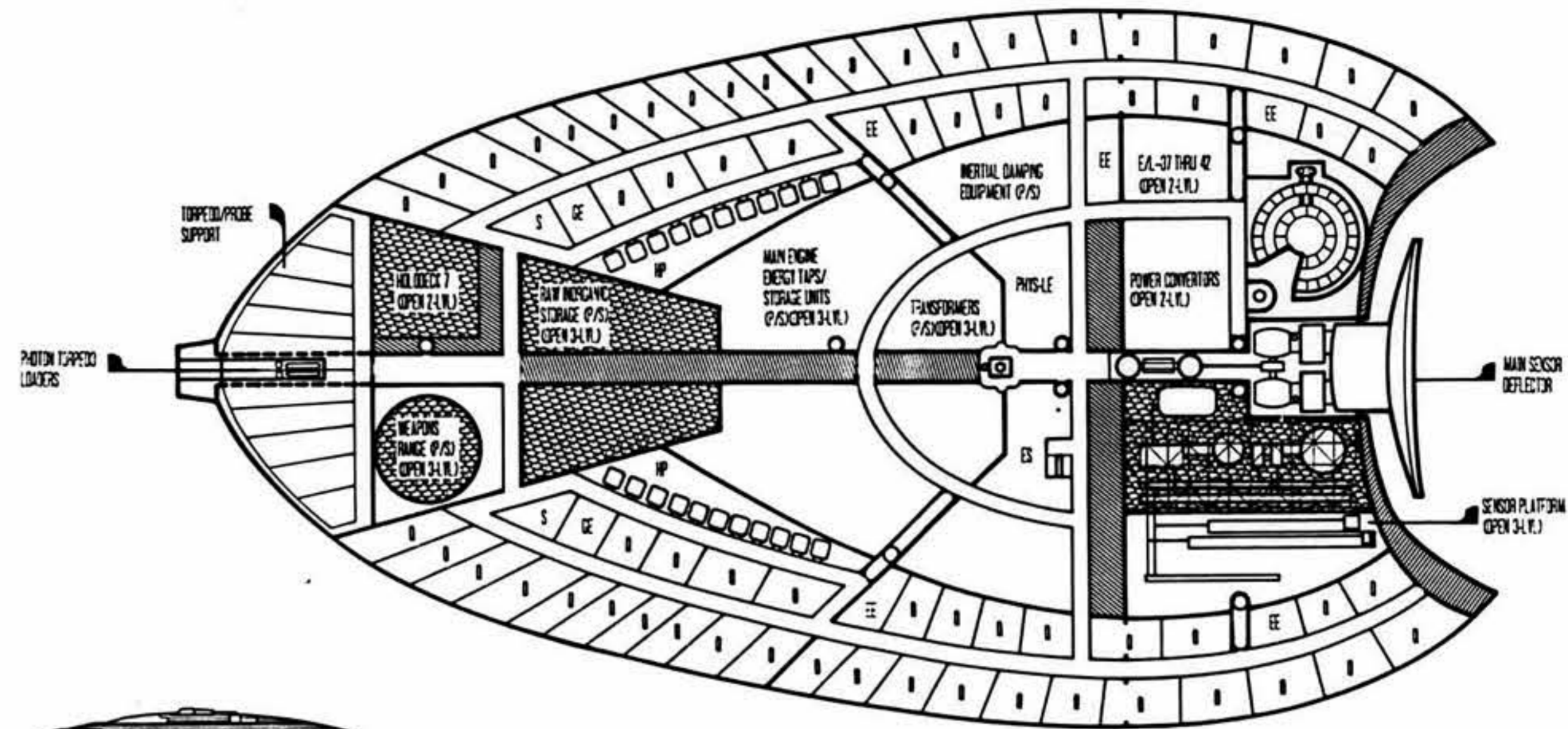

DECK 35
LIVING QUARTERS, AFT TORPEDO/PROBE LAUNCHER, ENGINEERING SUPPORT

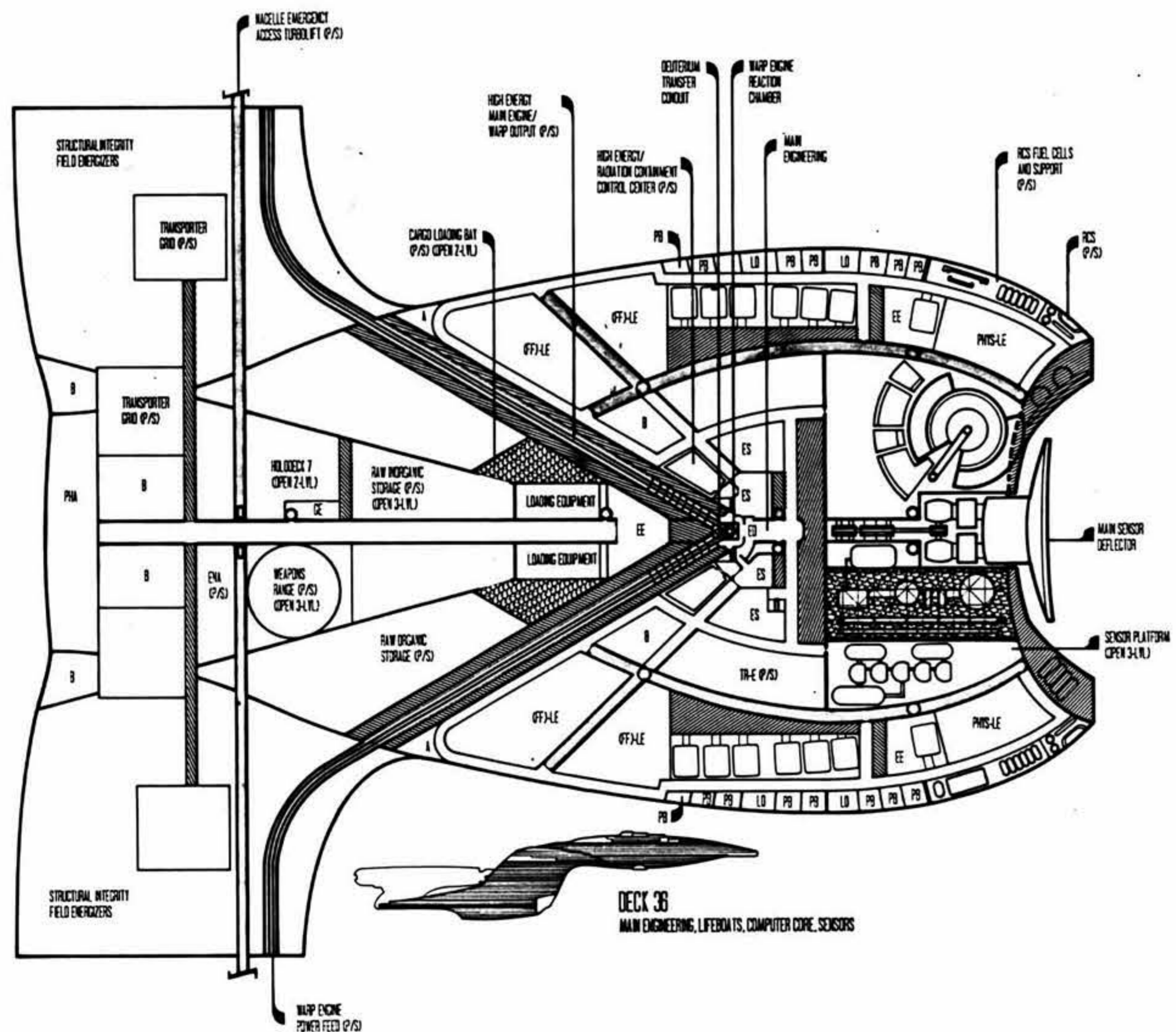

DECK 36
MAIN ENGINEERING, LIFERAFTS, COMPUTER CORE, SENSORS

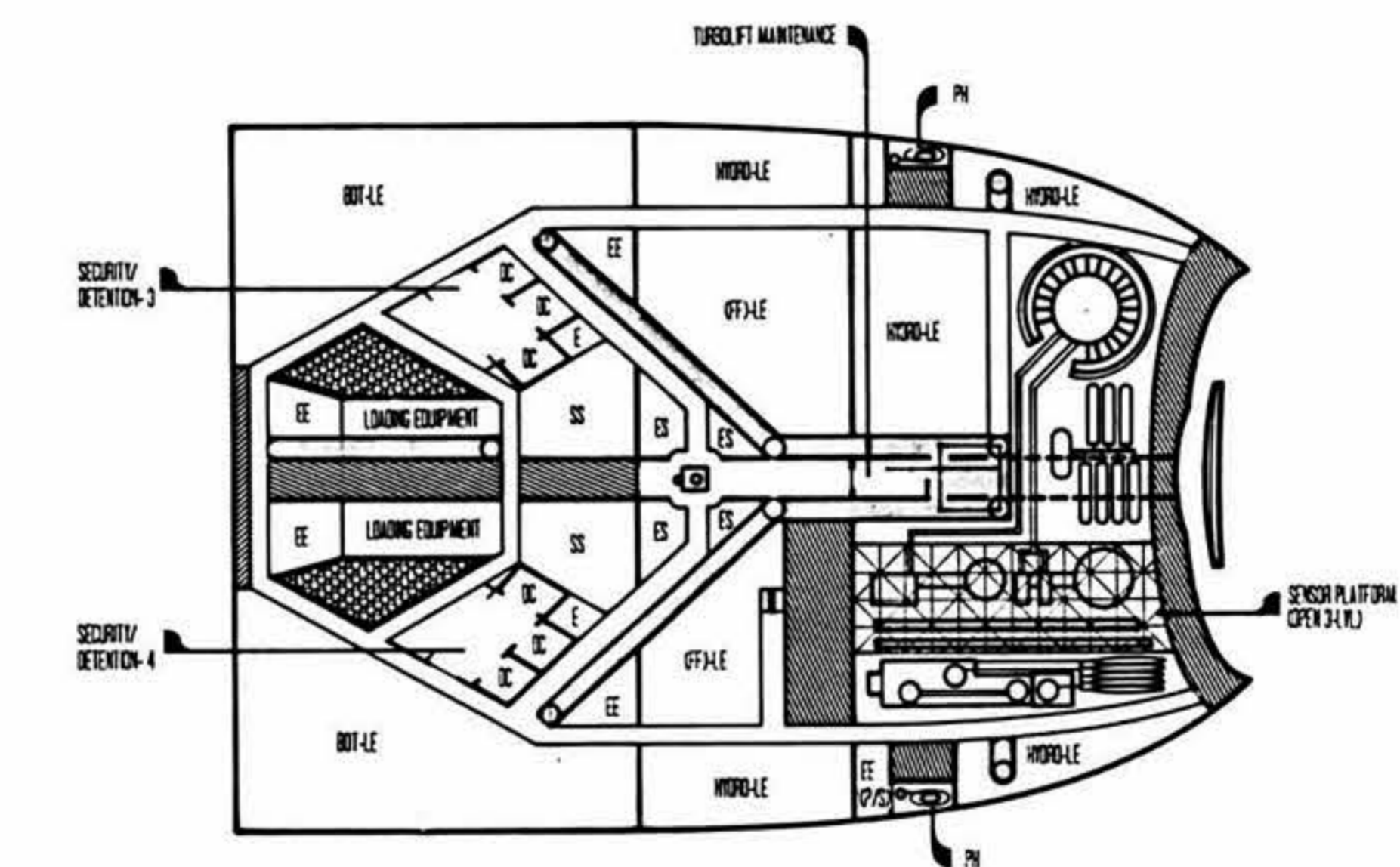

DECK 37
LIFE/ENVIRONMENTAL SUPPORT, ENGINEERING SUPPORT, SECONDARY WASTE MANAGEMENT

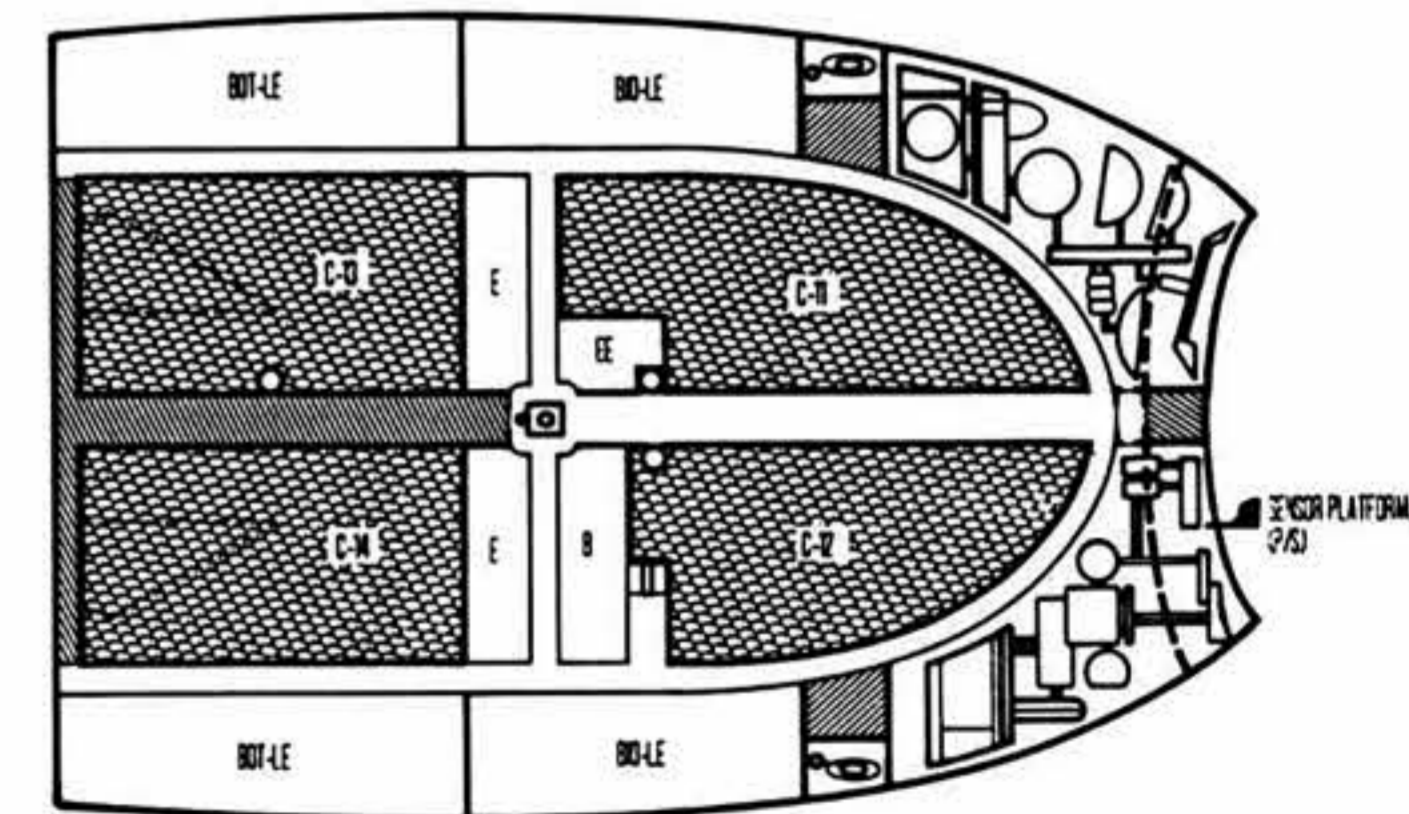

DECK 38
SECONDARY CARGO BAYS, SCIENCE LABS

		PROTOTYPE UPGRADE TO PRODUCTION STANDARDS
CLASS	GALAXY	U.S.S. ENTERPRISE
TYPE	NCC-1701-D	
PHASE	MARK III HEAVY CRUISER	- SECONDARY HULL - DECK 34 - DECK 37 - DECK 35 - DECK 38 - DECK 36
DESIGNED BY	EDWIN LEE ZAMORA	
CONSTRUCTION NUMBER	400078	
OFFICIAL NUMBER	417883	
		12 OF 13

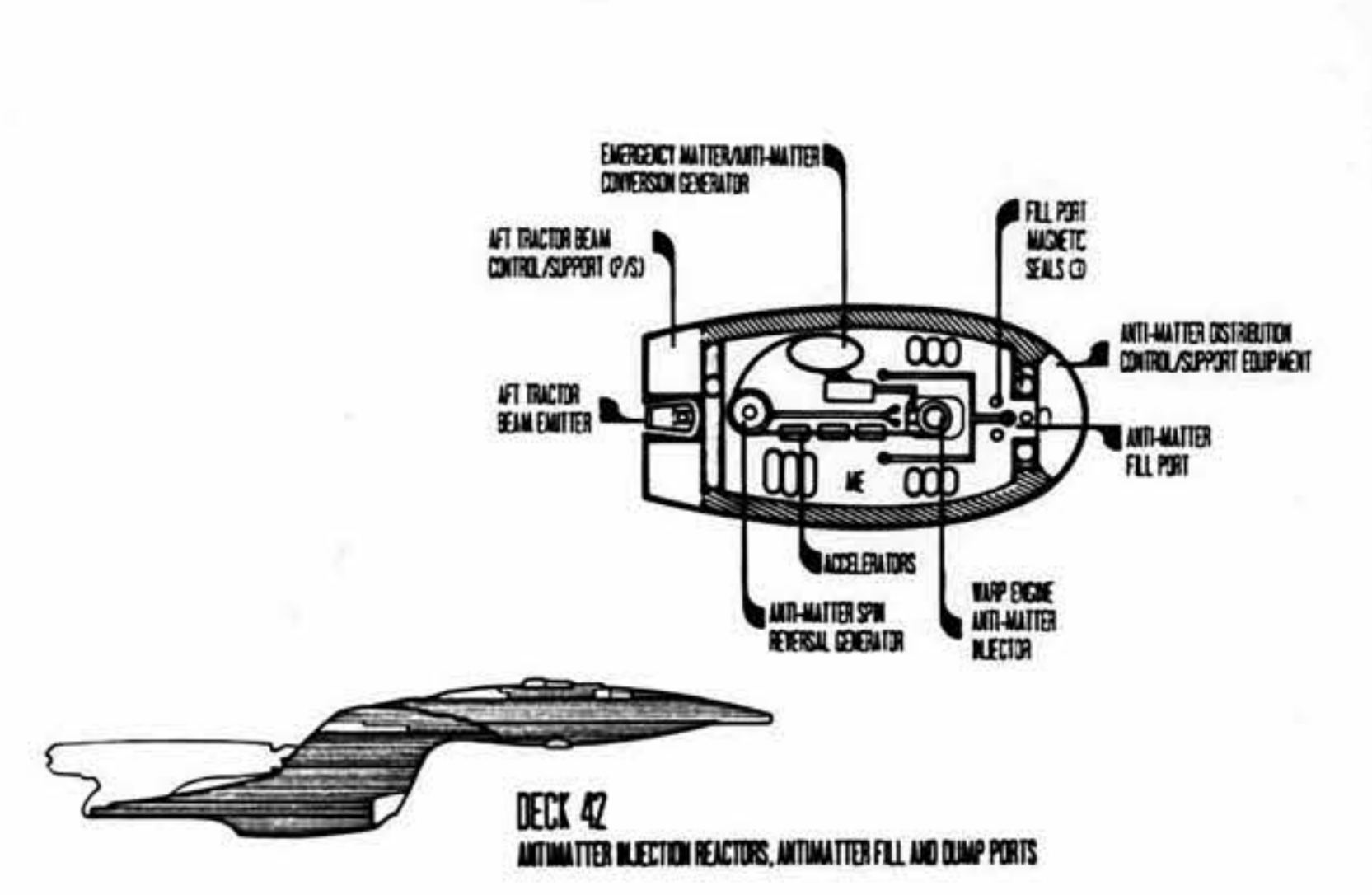
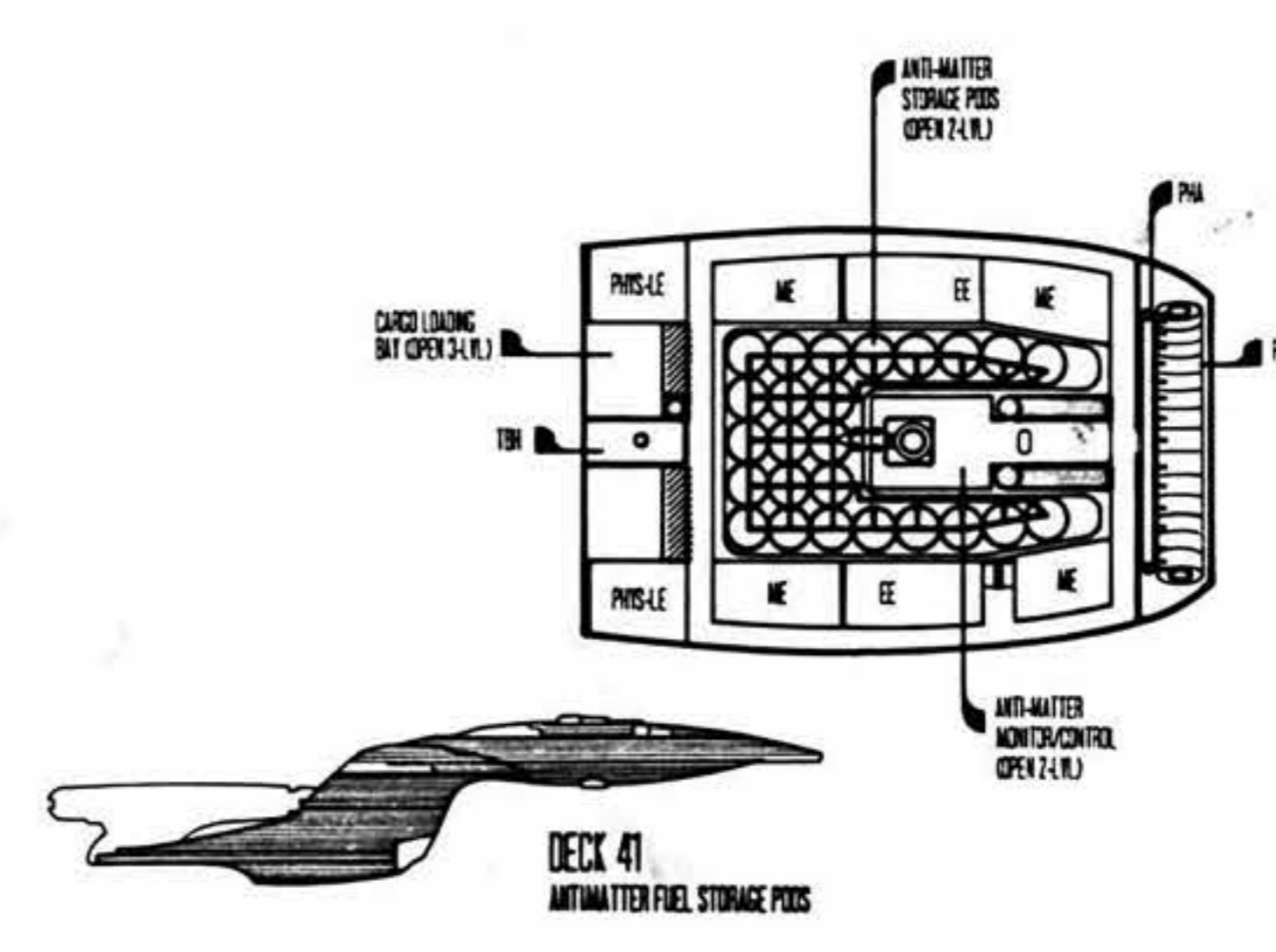
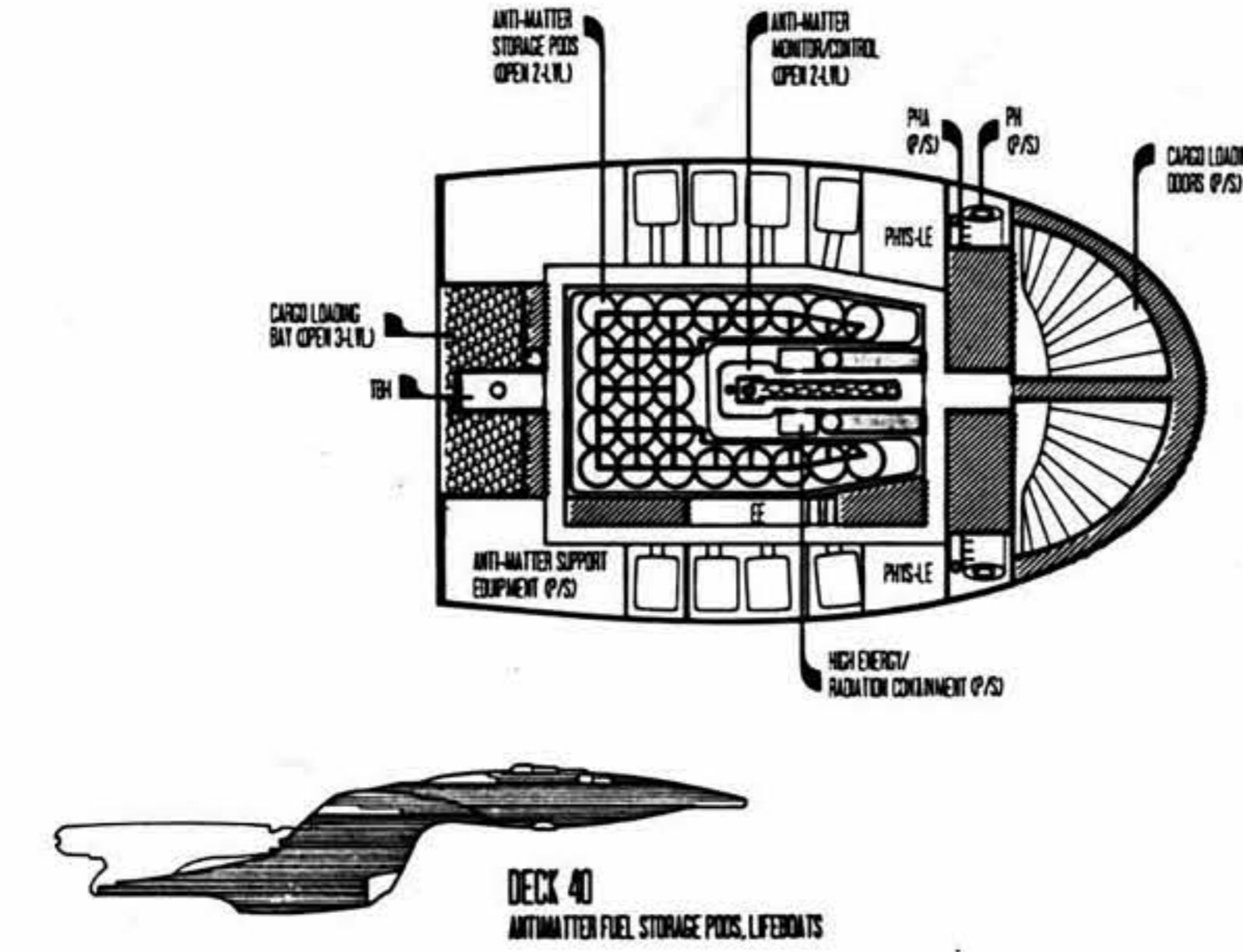
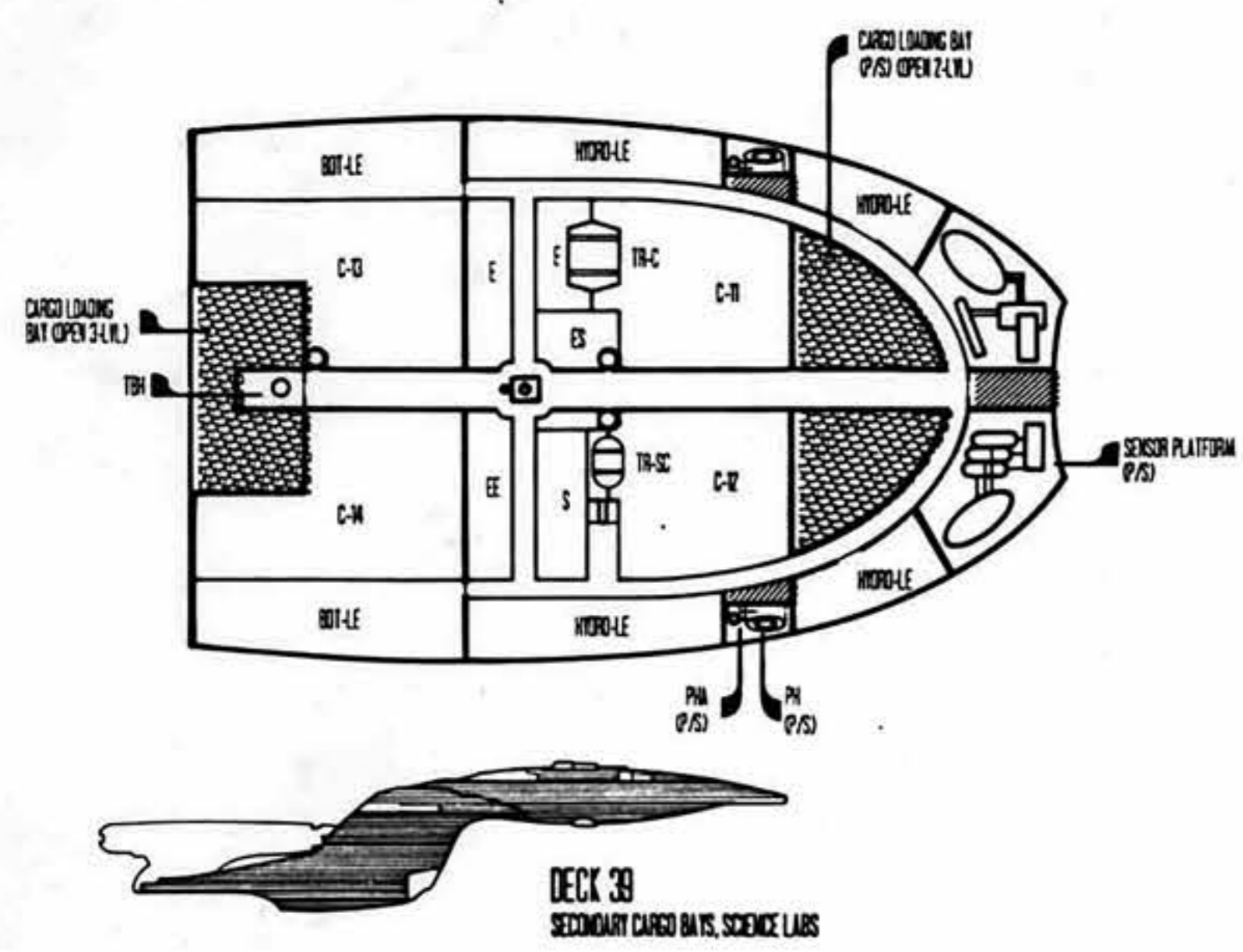

APPENDIX: ABBREVIATIONS

- | | |
|---|---|
| A - AIRLOCK | BD - OBSERVATION BAY/COMMON (OPEN 'Y' LEVEL) |
| AW - ASTROPHYSICAL SCIENCES | BO - VERTICAL OPEN SPACE 'Y' LEVELS (CHECKS) HIGH |
| BA - EMERGENCY BATTERIES | BR - OPERATING ROOM |
| BI - BRIDGE | BRP - OPERATING ROOM PREP/AM |
| BS - BIOLOGICAL SCIENCES | P - POWER/ELECTRICAL CLOSET |
| BT - BOTANICAL SCIENCES | PH - PORTACT/OBSERVATION ROOM |
| CA - CARGO ACCESS DOOR(S) | PH - PHASER BANK ARMAY |
| CD - COMPUTER BUS | PMA - PHASER ACCELERATION |
| CEM - CHEMICAL SCIENCES (CHEMIST) | PSTR - PHYSICAL SCIENCES |
| CM - COMPUTER MONITOR STATION | Q/P - POINT AND STAIRWELL LOCATIONS |
| CMS - CARGO MONITOR STATION | Q - LIVING QUARTERS |
| C-'Y' - CARGO BAY NUMBER 'Y' | RC - SHUTTLECRAFT REPAIR CELLS |
| CC - RETENTION CELL | RC - REACTION CONTROL SYSTEM |
| CE - SUPPORT EQUIPMENT CLOSET | R - GENERAL STORAGE |
| EE - EMERGENCY EQUIPMENT | SA - GENERAL STORAGE/CARGO TUB ACCESS |
| EA-'Y' - ENVIRONMENTAL/LIFE SUPPORT FOR DECKS 'Y' | SM - REASON MONITOR STATION |
| EG - EMERGENCY LIFES | SS - SPECIALIZER STORAGE |
| EMA - EMERGENCY MANEUVER CONTROL/ACCESS | TR - TRACTOR BEAM EMITTER HOUSING |
| EO - CHIEF ENGINEERS OFFICE/CONTROL CENTER | TM - TRANSPORTER ROOM (STANDARD 8-PERSON) |
| ES - ENGINEERING SUPPORT | TR-E - EMERGENCY TRANSPORTER ROOM (40-PERSON OUT-BEAM ONLY) |
| ET - EMERGENCY VERTING | TR-F - STANDARD CARGO TRANSPORTER |
| ETM - EMERGENCY VERTING MONITOR STATION | TR-S - SMALL CARGO TRANSPORTER |
| EW - EMERGENCY WARD/WATERSIDE CAGE | TR - TREATMENT WARD |
| EV - EMERGENCY WARD - ISOLATION | |
| (FF) - UNDES (FOR FUTURE EXPANSION AND REFT) | |
| GE - STYANASION/HOLODECK EQUIPMENT AND WARDROBE | |
| GS - GEOLOGICAL SCIENCES | |
| H - HEAD | |
| HA - SHUTTLECRAFT HANGAR | |
| HP - PERSONAL P.A.Y. HOLD-ROOMS | |
| HS - HULLDECK SUPPORT | |
| HY - HYDROPHYSICS | |
| I - INFIRMARY | |
| IV - ISOLATION INFIRMARY | |
| L - LIFEBOAT ACCESS/EXTERNAL EGRESS | |
| LE - MEDICAL LABORATORY | |
| 'Y'-LE - LABORATORY BAY/LABORATORY EQUIPMENT BAY FOR 'Y' | |
| LM - LIFEBOAT MONITOR STATION/OVERRIDE CONTROL | |
| LO - LOBBY | |
| L1 - PRIMARY HULL LOCKS AND STRUCTURAL FIELD SUPPORT GENERATORS | |
| L2 - SECONDARY HULL LOCKS AND STRUCTURAL FIELD SUPPORT GENERATORS | |
| LA - MAGNETIC LOCK | |
| ME - MAGNETIC LOCK EQUIPMENT BAY | |
| MM - CHIEF SURGEONS' OFFICE (CHIEF MEDICAL OFFICER) | |

APPENDIX: SYMBOLS

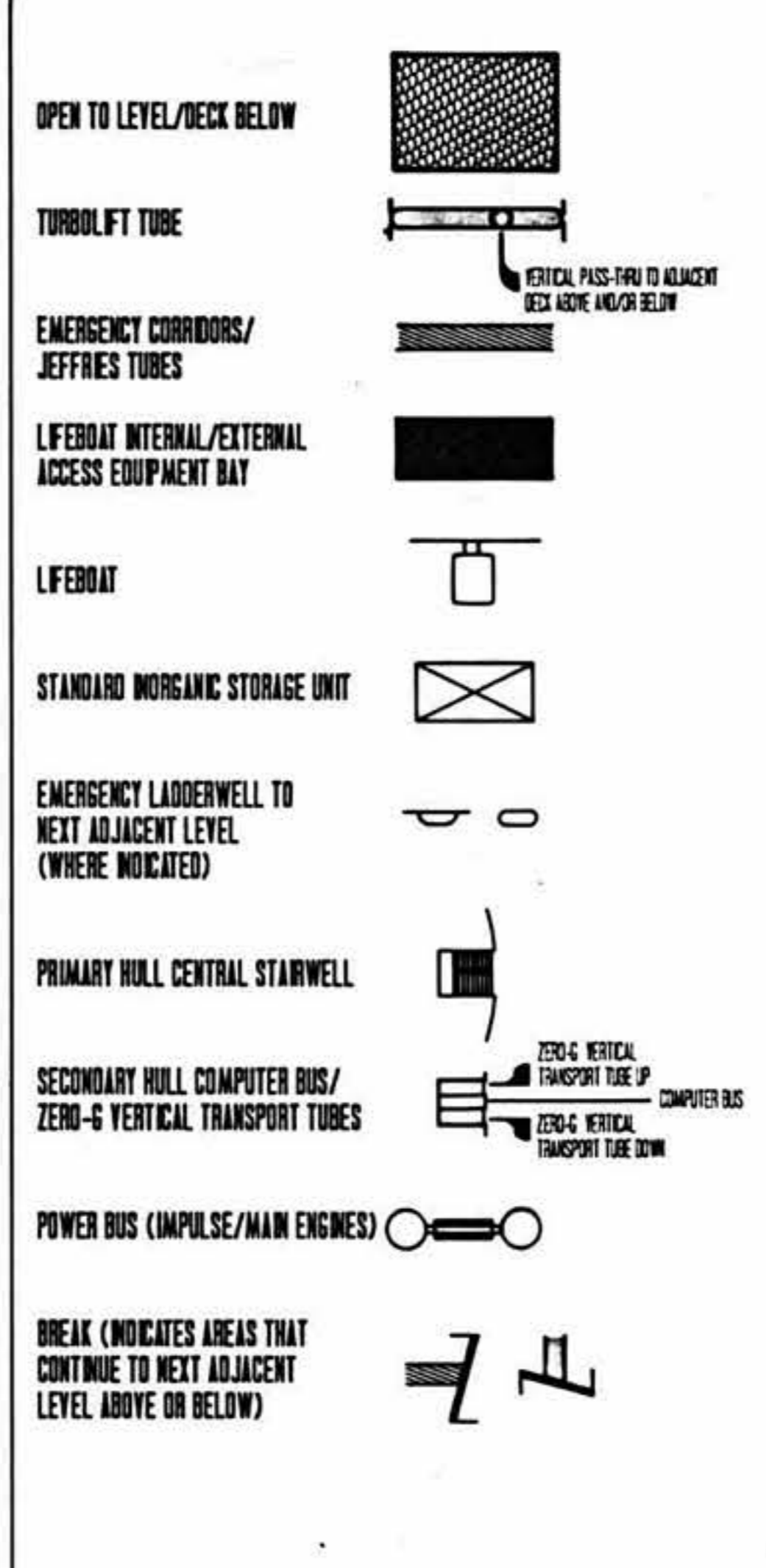

APPENDIX: PARTICULARS

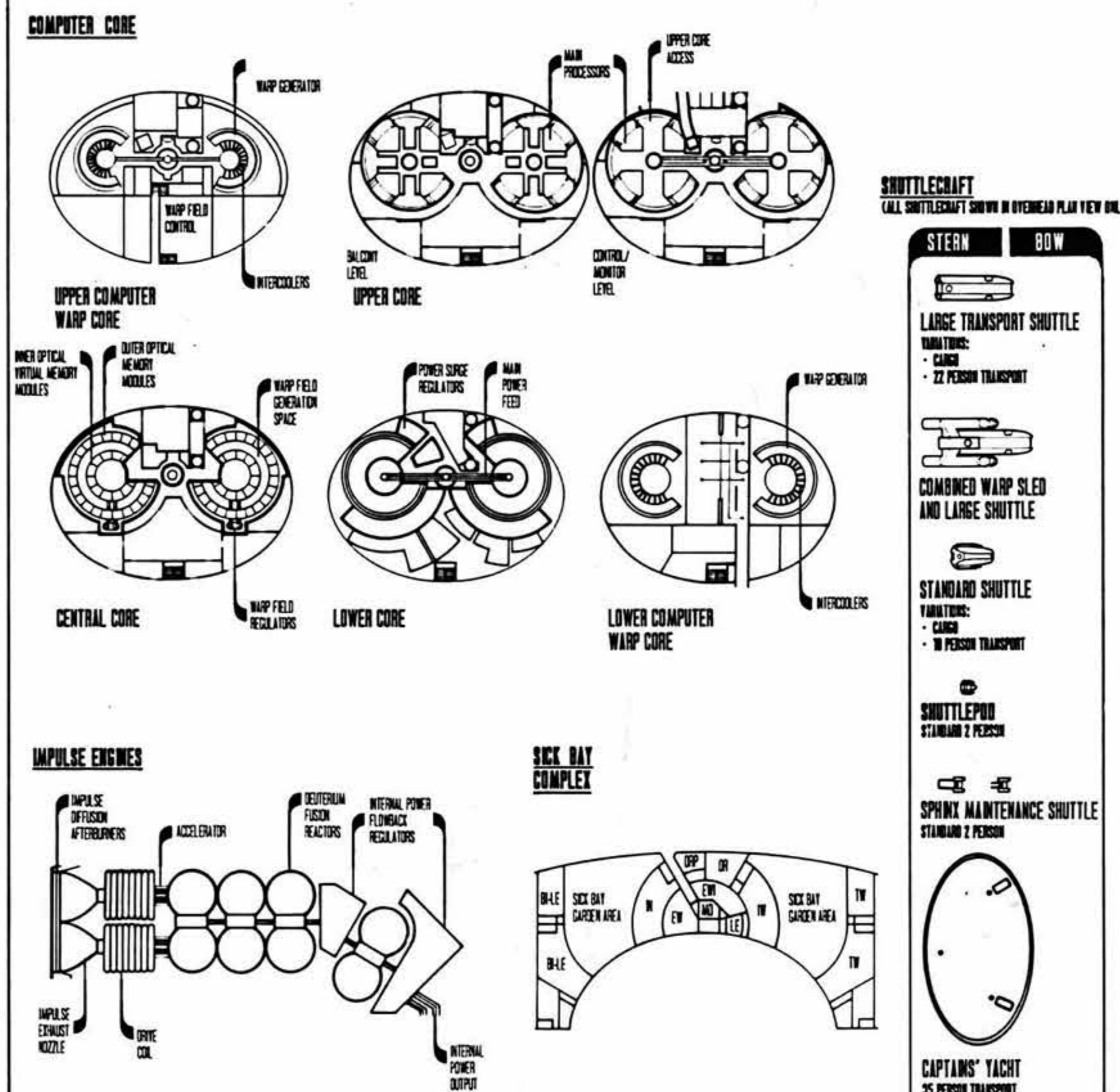

APPENDIX: NOTES

- THIS SET OF PLANS IS PROVIDED FOR STAR FLEET PERSONNEL AND THEIR FAMILIES TO FAMILIARIZE THEMSELVES WITH THE WORKINGS OF THE GALAXY CLASS HEAVY CRUISER. RELEASE OF THIS DATA TO PEOPLE NOT ASSIGNED TO THE GALAXY CLASS STARSHIP AND/OR NOT DIRECTLY ATTACHED TO STAR FLEET IS STRICTLY PROHIBITED.
- NUMBER OF SHUTTLES, EQUIPMENT AVAILABILITY, VARIOUS EQUIPMENT/PLAN LOCATIONS AND CREW COMPLEMENT WILL VARY FROM SHIP TO SHIP AS REQUIREMENTS DICTATE; THESE STANDARDS WILL ALSO CHANGE ON-BRAND SHIP AFTER SUBSEQUENT REFFITS. LAST MAJOR REFFIT COMPLETION: STANBATE - 41780.3
- REPLACEMENT OF NUMEROUS STANDARD (8-PERSON) TRANSPORTERS (FOUND TO BE REDUNDANT) WITH LARGE CAPACITY EMERGENCY TRANSPORTERS (40-PERSON) AND CARGO TRANSPORTERS; MODIFICATION AND REPLACEMENT OF NUMEROUS SENSORS; UNDESIGN UPGRADE.
- CREW AND GUEST QUARTERS/STATEROOMS ARE VARIABLE IN SIZE AND DESIGN ACCORDING TO INDIVIDUAL TASTES AND FAMILY UNIT SIZES; SINGLE OFFICERS AND COLONEL CREW ALIKE ARE PROVIDED INDIVIDUAL QUARTERS, UNLIKE PREVIOUS STARSHIP CLASSES WHERE CREW ARE REQUIRED TO SHARE CABS.
- ALL LIFEBOATS ARE STANDARD 8-PERSON CAPACITY EXPANDING UNITS (THROUGH LIFEBOATS ARE 4-CAPACITY UNITS). LIFEBOATS MAY BE ACTIVATED AND LAUNCHED MANUALLY IN CASE OF POWER LOSS. EACH LIFEBOAT UNIT MAY BE LOADED WITH OTHER UNITS IN GROUPS OR IN CHAINS (END-TO-END) AFTER LAUNCH. ALL LIFEBOATS HAVE SUPPLIES AND POWER FOR UP TO 2-WEEKS LIFE-SUPPORT AND ARE PROVIDED WITH LOW POWER WARP/SLIP AND R.C.S. TRANSDUCERS. APPROXIMATELY ONE IN SIX LIFEBOATS IS A SUPPLY/POWER UNIT CAPABLE OF EXTENDING LIFE-SUPPORT BY UP TO 2-WEEKS WHEN IN COMBINATION WITH ONE OR MORE LIFEBOATS (SUPPLY/POWER UNIT LIFEBOATS HAVE A 2-PERSON CAPACITY).
- ON-BRAND GRAVITY IS CONTROLLED BY MULTIPLE GRAVITATIONAL UNITS (APPROXIMATELY 10cm DIAMETER DISCS) PLACED IN THE FLOORING OF EACH DECK (INCLUDING TURBOLIFTS). GRAVITATIONAL FIELDS ARE ADJUSTABLE THROUGHOUT THE SHIP TO SUIT INDIVIDUAL ENVIRONMENTS AND NEEDS.
- ACCELERATION AND DECELERATION EFFECTS ARE COUNTERED BY INERTIA DAMPERS GENERATORS, LOCATED AT VARIOUS POSITIONS THROUGHOUT THE SHIP. INERTIA DAMPERS GENERATORS WORK IN TANDUM WITH ALL THRUSTER FUNCTIONS (MAIN, IMPULSE, AND R.C.S.).
- MAINTENANCE OF SHIP'S STRUCTURE IS CONTROLLED BY STRUCTURAL INTENSITY FIELD ENGINEERS LOCATED THROUGHOUT THE SHIP; THE FIELD GENERATED BY THE ENGINEERS REINFORCES ALL PRIMARY AND SECONDARY SHIP'S BULKHEADS WHEN SPEEDS EXCEED WARP 1.
- ALL MAIN AIRLOCKS, CARGO DOCKS, AND DOCKING PORTS ARE NOTED; EMERGENCY AIRLOCKS ARE LOCATED ON ALL DECKS AND ARE NOT INDICATED FOR PURPOSES OF CLARITY.
- ALL DIMENSIONS ARE IN THE METRIC SYSTEM OF THE UNITED FEDERATION OF PLANETS.
- THE GALAXY CLASS STARSHIP IS EQUIPPED TO SEPARATE THE PRIMARY HULL FROM THE SECONDARY (ENGINEERING) HULL IN CASE OF EXTREME EMERGENCY OF BATTLE CONDITIONS; HOWEVER, THE GALAXY CLASS STARSHIP IS CAPABLE OF RECONNECTING INTO SECTIONS TO RESUME NORMAL MESSOR OPERATIONS AFTER AN EMERGENCY OR BATTLE CONDITIONS IS PASSED (A FEATURE PREVIOUSLY PRESENT ONLY ON THE ABBASION CLASS HEAVY CRUISER). WHEN SEPARATED INTO SECTIONS ARE CAPABLE OF INDEPENDENT INTERNAL FUNCTIONS AT MINIMAL LEVELS. THE FOLLOWING SPECIFICATIONS OUTLINE THE GALAXY CLASS HEAVY CRUISER CAPABILITIES WHEN IN A SEPARATED CONDITION:

	PRIMARY HULL	SECONDARY (ENGINEERING) HULL
MAXIMUM PERSONNEL CAPACITY	15,000	3,000
MAXIMUM VELOCITY	WARP .45	WARP 0.8
DRIVE UNITS	4 STANDARD IMPULSE ENGINES/ 12 FUSION REACTORS (4 BACKUP REACTORS)	2 HIGH-ENERGY IMPULSE ENGINES/ 4 FUSION REACTORS (2 BACKUP REACTORS) 2 WARP FIELD ENGINES 1 MATTER/ANTI-MATTER FUSION REACTOR
AVAILABLE LIFEBOATS	300 STANDARD 50 SUPPLY UNITS	31 STANDARD 8 SUPPLY UNITS
WEAPONRY	2 MULTI-DIRECTIONAL TYPE 3 PHASERS 1 PHOTON TORPEDO TUBE	10 MULTI-DIRECTIONAL TYPE 2 PHASERS 2 PHOTON TORPEDO TUBES (EXCLUSIVE AFT FIBING ONLY)

PROTOTYPE UPGRADE TO PRODUCTION STANDARDS

CLASS: GALAXY	CLASS: U.S.S. ENTERPRISE
MODEL: NCC-1701-D	MODEL: - SECONDARY HULL
DESIGNER: MAJ. JIM HEATH CRUISER	DESIGNER: - DECK 38
DESIGNER: EDWIN LEE ZANCAN	DESIGNER: - DECK 40
DESIGNER: EDWIN LEE ZANCAN	DESIGNER: - DECK 41
DESIGNER: EDWIN LEE ZANCAN	DESIGNER: - DECK 42

DATE: 4000.8
BY: EDWIN LEE ZANCAN
41789.3

13 OF 13